



SIERBESLAG





Viefe® furnipart®

Klassiek, eigentijds of liever eigenzinnig?

Bij Du Pont zijn we erg verheugd u te mogen voorstellen aan onze nieuwe catalogus sierbeslag! Elke knop en greep die u kan terugvinden in dit overzicht hebben wij steeds op voorraad in onze magazijnen in Grobbendonk. Hierdoor kunnen we u alle grepen ook presenteren in onze showroom zodat u (of uw klant) deze ten volle kan ervaren.

ONZE VOORDELEN

- Zeer breed en uitgebreid programma: modern, klassiek, antiek...
- Voorraad bij ons — niet bij u
- Speciale voorwaarden voor showroom-toepassingen
- Ondersteuning met documentatie
- Levering met eigen chauffeurs

Het aanbod dat wij in voorraad nemen is uiteraard slechts een segment uit het volledige aanbod van onze trouwe toeleveranciers. Bent u op zoek naar nét die andere greep voor uw project? Of wilt u iets exclusiefs? Of heeft u zelf een idee voor een greep? Ons team van experts zal u graag bijstaan in uw zoektocht naar de gepaste greep voor uw project.

Alle knoppen en grepen die in deze catalogus worden vermeld leveren wij per order. U moet dus geen nodeloze stocks aanleggen en u kan toch, aan de hand van deze catalogus, een zeer ruim aanbod aanbieden aan uw klanten zonder problemen met levertijden. Tevens sturen wij u niet alleen uw order toe, we verpakken uw bestelling ook individueel met een duidelijk etiket met vermelding van uw referentie. Zo kunt u deze onmiddellijk toewijzen aan uw meubel, keuken of badkamer. Gedaan met tijdverlies!

team Du Pont



Greep: EDGE, Dressing: Darby Doors

I N H O U D

- A. Moderne & klassieke grepen
- B. Grepen voor hoge deuren
- C. Infrees & opzetgrepen
- D. Moderne & klassieke knoppen
- E. Houten knoppen & grepen
- F. Black & White collection
- G. Gietijzer knoppen & grepen
- H. Darby Doors knoppen & grepen
- I. Outdoor collection
- J. Handdoekrekken & kapstokhaken
- K. Antieke knoppen & grepen
- L. Project grepen (economisch)
- M. Meubelpoten
- N. Verwerking

Moderne & klassieke grepen

Ze bepalen het cachet van het meubel en bieden een meerwaarde aan het design. Wij stellen onze collectie steeds samen op basis van de ervaringen met onze klanten. Momenteel heerst er een zeer sterke trend naar zwarte grepen, maar ook de mat gouden grepen in combinatie met eiken accenten lijken erg terug in trek. In ons nieuwe programma moderne en klassieke grepen houden we hier al rekening mee en hebben we verschillende nieuwe modellen toegevoegd.

Technische Fiche



QUART MINI knop & greep

KNOP	UITVOERING	AFMETINGEN	HOOGTE	BEVESTIGING	ARTIKEL NR.	SNELCODE	
Knop	Messing geborsteld	26x26mm	24mm	M4	VIE0608-26-MES	60801	
Knop	Brons antiek	26x26mm	24mm	M4	VIE0608-26-BA	60802	
Knop	Mat zwart	26x26mm	24mm	M4	VIE0608-26-ZW	60803	
GREEP	UITVOERING	BOORAFSTAND	OVERMETEN	HOOGTE	BEVESTIGING	ARTIKEL NR.	SNELCODE
Greep	Messing geborsteld	128mm	146mm	31mm	M4	VIE0608-128-MES	60804
Greep	Brons antiek	128mm	146mm	31mm	M4	VIE0608-128-BA	60805
Greep	Mat zwart	128mm	146mm	31mm	M4	VIE0608-128-ZW	60806

Technische Fiche



QUART BIG knop & greep

KNOP	UITVOERING	AFMETINGEN	HOOGTE	BEVESTIGING	ARTIKEL NR.	SNELCODE
Knop	Messing geborsteld	34x34mm	31mm	M4	VIE0616-34-MES	61601
Knop	Brons antiek	34x34mm	31mm	M4	VIE0616-34-BA	61602
Knop	Mat zwart	34x34mm	31mm	M4	VIE0616-34-ZW	61603

GREEP	UITVOERING	BOORAFSTAND	OVERMETEN	HOOGTE	BEVESTIGING	ARTIKEL NR.	SNELCODE
Greep	Messing geborsteld	160mm	184mm	35mm	M4	VIE0616-160-MES	61604
Greep	Brons antiek	160mm	184mm	35mm	M4	VIE0616-160-BA	61605
Greep	Mat zwart	160mm	184mm	35mm	M4	VIE0616-160-ZW	61606

Technische Fiche



VALLEY greep

UITVOERING	BOORAFSTAND	OVERMETEN	HOOGTE	BEVESTIGING	ARTIKEL NR.	SNELCODE
Messing glans	160mm	223mm	25mm	M4	VIE0602-160-MBL	60201
Messing geborsteld	160mm	223mm	25mm	M4	VIE0602-160-MK	60202
Zwart glans	160mm	223mm	25mm	M4	VIE0602-160-ZG	60203
Zwart mat	160mm	223mm	25mm	M4	VIE0602-160-ZM	60204
Messing glans	256mm	330mm	25mm	M4	VIE0602-256-MBL	60206
Messing geborsteld	256mm	330mm	25mm	M4	VIE0602-256-MK	60205
Zwart glans	256mm	330mm	25mm	M4	VIE0602-256-ZG	60207
Zwart mat	256mm	330mm	25mm	M4	VIE0602-256-ZM	60208

Technische Fiche



FLAPP greep aluminium

UITVOERING	BOORAFSTAND	OVERMETEN	HOOGTE	BEVESTIGING	ARTIKEL NR.	SNELCODE
Inox look	32mm	70mm	22mm	M4	VIE0610-070-IL	61004
Zwart mat	32mm	70mm	22mm	M4	VIE0610-070-ZM	61005
Messing	32mm	70mm	22mm	M4	VIE0610-070-MES	61006
Inox look	128 & 160mm	200mm	22mm	M4	VIE0610-160-IL	61002
Zwart mat	128 & 160mm	200mm	22mm	M4	VIE0610-160-ZM	61001
Messing	128 & 160mm	200mm	22mm	M4	VIE0610-160-MES	61003
Inox look	256mm	350mm	22mm	M4	VIE0610-350-IL	61007
Zwart mat	256mm	350mm	22mm	M4	VIE0610-350-ZM	61008
Messing	256mm	350mm	22mm	M4	VIE0610-350-MES	61009
Inox look	416 & 1056	1100mm	22mm	M4	VIE0610-1100-IL	61010
Zwart mat	416 & 1056	1100mm	22mm	M4	VIE0610-1100-ZM	61011
Messing	416 & 1056	1100mm	22mm	M4	VIE0610-1100-MES	61012

Technische Fiche



BELT knop

UITVOERING	AFMETINGEN	HOOGTE	BEVESTIGING	ARTIKEL NR.	SNELCODE
Mokka bruin	22x63mm	29mm	M4	VIE0590-63-MB	59005
Mos grijs	22x63mm	29mm	M4	VIE0590-63-MG	59003
Mat wit	22x63mm	29mm	M4	VIE0590-63-MW	59001
Mat zwart	22x63mm	29mm	M4	VIE0590-63-MZ	59002
Vulkaan rood	22x63mm	29mm	M4	VIE0590-63-VR	59006
Woud groen	22x63mm	29mm	M4	VIE0590-63-WG	59004

BELT greep

UITVOERING	BOORAFSTAND	OVERMETEN	HOOGTE	BEVESTIGING	ARTIKEL NR.	SNELCODE
Mokka bruin	160mm	222mm	28mm	M4	VIE0590-160-MB	59011
Mos grijs	160mm	222mm	28mm	M4	VIE0590-160-MG	59009
Mat wit	160mm	222mm	28mm	M4	VIE0590-160-MW	59007
Mat zwart	160mm	222mm	28mm	M4	VIE0590-160-MZ	59008
Vulkaan rood	160mm	222mm	28mm	M4	VIE0590-160-VR	59012
Woud groen	160mm	222mm	28mm	M4	VIE0590-160-WG	59010

Ook beschikbaar als kapstokhaak, zie pagina J 5.

Technische Fiche



LUV knop zamak

UITVOERING	BREEDTE X LENGTE	HOOGTE	BEVESTIGING	ARTIKEL NR.	SNELCODE
Messing	18x51mm	31mm	M4	VIE0536-17-GM	53601
Nikkel	17x51mm	31mm	M4	VIE0536-17-NI	53602
Mat wit	17x51mm	31mm	M4	VIE0536-17-WI	53603
Mat zwart	17x51mm	31mm	M4	VIE0536-17-ZW	53604

LUV greep zamak

UITVOERING	BOORAFSTAND	OVERMETEN	HOOGTE	BEVESTIGING	ARTIKEL NR.	SNELCODE
Messing	192mm	202mm	31mm	M4	VIE0536-192-GM	53605
Nikkel	192mm	202mm	31mm	M4	VIE0536-192-NI	53606
Mat wit	192mm	202mm	31mm	M4	VIE0536-192-WI	53607
Mat zwart	192mm	202mm	31mm	M4	VIE0536-192-ZW	53608
Messing	320mm	330mm	31mm	M4	VIE0536-320-GM	53609
Nikkel	320mm	330mm	31mm	M4	VIE0536-320-NI	53610
Mat wit	320mm	330mm	31mm	M4	VIE0536-320-WI	53611
Mat zwart	320mm	330mm	31mm	M4	VIE0536-320-ZW	53612

A MODERNE & KLASSIEKE GREPEN

Technische Fiche



PURA greep zamak

UITVOERING	BOORAFSTAND	OVERMETEN	HOOGTE	BEVESTIGING	ARTIKEL NR.	SNELCODE
Koper glans	160mm	168mm	28mm	M4	VIE0487-160-KOP	48701
Messing glans	160mm	168mm	28mm	M4	VIE0487-160-MES	48702
Zwart glans	160mm	168mm	28mm	M4	VIE0487-160-ZW	48703
Chrome glans	160mm	168mm	28mm	M4	VIE-0487-160-CHR	48704

Technische Fiche



RILLE knop & greep aluminium

UITVOERING	BOORAFSTAND	OVERMETEN	HOOGTE	BEVESTIGING	ARTIKEL NR.	SNELCODE
Inox look	-	55mm	39mm	M4	VIE0528-55-IL	52801
Messing	-	55mm	39mm	M4	VIE0528-55-MES	52802
Zwart	-	55mm	39mm	M4	VIE0528-55-ZW	52803
Inox look	160mm	190mm	39mm	M4	VIE0528-160-IL	52804
Messing	160mm	190mm	39mm	M4	VIE0528-160-MES	52805
Zwart	160mm	190mm	39mm	M4	VIE0528-160-ZW	52806
Inox look	320mm	350mm	39mm	M4	VIE0528-320-IL	52807
Messing	320mm	350mm	39mm	M4	VIE0528-320-MES	52808
Zwart	320mm	350mm	39mm	M4	VIE0528-320-ZW	52809
Inox look	480mm	510mm	39mm	M4	VIE0528-480-IL	52810
Messing	480mm	510mm	39mm	M4	VIE0528-480-MES	52811
Zwart	480mm	510mm	39mm	M4	VIE0528-480-ZW	52812
Inox look	496/992mm	1022mm	39mm	M4	VIE0528-992-IL	52813
Messing	496/992mm	1022mm	39mm	M4	VIE0528-992-MES	52814
Zwart	496/992mm	1022mm	39mm	M4	VIE0528-992-ZW	52815



FUSION Glans knop zamak

UITVOERING	OVERMETEN	HOOGTE	BEVESTIGING	ARTIKEL NR.	SNELCODE
Titanium zwart	58mm	32mm	M4	VIE0627058-ZN	62701
Nikkel	58mm	32mm	M4	VIE0627058-GN	62702
Messing	58mm	32mm	M4	VIE0627058-GMES	62703

Knop inclusief extra punt om doordraaien te vermijden

FUSION Glans greep zamak

UITVOERING	BOORAFSTAND	OVERMETEN	HOOGTE	BEVESTIGING	ARTIKEL NR.	SNELCODE
Titanium zwart	160mm	180mm	32mm	M4	VIE0627160-ZN	62707
Nikkel	160mm	180mm	32mm	M4	VIE0627160-GN	62708
Messing	160mm	180mm	32mm	M4	VIE0627160-GMES	62709
Titanium zwart	320mm	340mm	32mm	M4	VIE0627320-ZN	62713
Nikkel	320mm	340mm	32mm	M4	VIE0627320-GN	62714
Messing	320mm	340mm	32mm	M4	VIE0627320-GMES	62715



FUSION Mat knop zamak

UITVOERING	OVERMETEN	HOOGTE	BEVESTIGING	ARTIKEL NR.	SNELCODE
Titanium zwart	58mm	32mm	M4	VIE0627058-MN	62704
Zwart	58mm	32mm	M4	VIE0627058-MZ	62706
Messing	58mm	32mm	M4	VIE0627058-MES	62705

Knop inclusief extra punt om doordraaien te vermijden

FUSION Mat greep zamak

UITVOERING	BOORAFSTAND	OVERMETEN	HOOGTE	BEVESTIGING	ARTIKEL NR.	SNELCODE
Titanium zwart	160mm	180mm	32mm	M4	VIE0627160-MN	62710
Zwart	160mm	180mm	32mm	M4	VIE0627160-MZ	62712
Messing	160mm	180mm	32mm	M4	VIE0627160-MES	62711
Titanium zwart	320mm	340mm	32mm	M4	VIE0627320-MN	62716
Zwart	320mm	340mm	32mm	M4	VIE0627320-MZ	62718
Messing	320mm	340mm	32mm	M4	VIE0627320-MES	62717



LINKK greep aluminium

UITVOERING	BOORAFSTAND	OVERMETEN	HOOGTE	BEVESTIGING	ARTIKEL NR.	SNELCODE
Inox look	160mm	175mm	37mm	M4	VIE0643160-IL	64301
Messing	160mm	175mm	37mm	M4	VIE0643160-MES	64302
Zwart	160mm	175mm	37mm	M4	VIE0643160-ZW	64303
Inox look	320mm	335mm	37mm	M4	VIE0643320-IL	64304
Messing	320mm	335mm	37mm	M4	VIE0643320-MES	64304
Zwart	320mm	335mm	37mm	M4	VIE0643320-ZW	64306
Inox look	528/ 1056mm	1071mm	37mm	M4	VIE06431056-IL	64307
Messing	528/ 1056mm	1071mm	37mm	M4	VIE06431056-MES	64308
Zwart	528/ 1056mm	1071mm	37mm	M4	VIE06431056-ZW	64309

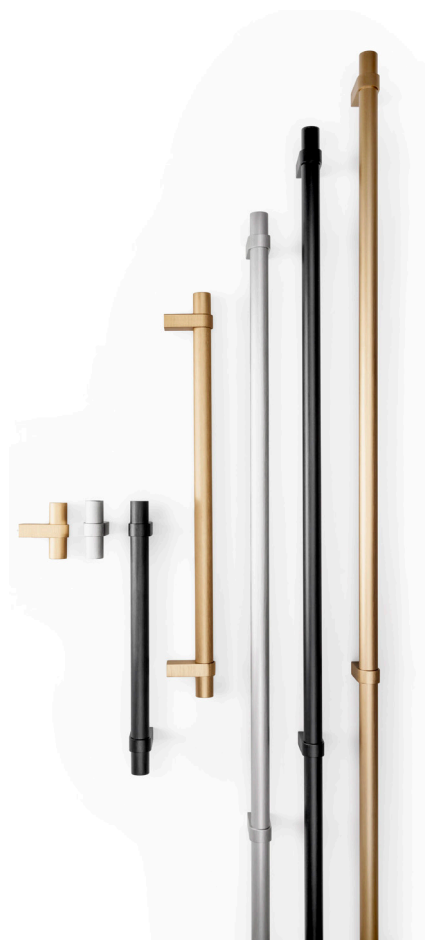

NOBB knop & greep aluminium

UITVOERING	BOORAFSTAND	OVERMETEN	HOOGTE	BEVESTIGING	ARTIKEL NR.	SNELCODE
Inox look	/	52mm	45mm	M4	VIE0657-0052-IL	65701
Zwart	/	52mm	45mm	M4	VIE0657-0052-ZW	65702
Messing	/	52mm	45mm	M4	VIE0657-0052-MES	65703
Inox look	192mm	244mm	45mm	M4	VIE0657-0192-IL	65704
Zwart	192mm	244mm	45mm	M4	VIE0657-0192-ZW	65705
Messing	192mm	244mm	45mm	M4	VIE0657-0192-MES	65706
Inox look	320mm	372mm	45mm	M4	VIE0657-0320-IL	65707
Zwart	320mm	372mm	45mm	M4	VIE0657-0320-ZW	65708
Messing	320mm	372mm	45mm	M4	VIE0657-0320-MES	65709
Inox look	528/1056mm	1108m	45mm	M4	VIE0657-1056-IL	65710
Zwart	528/1056mm	1108m	45mm	M4	VIE0657-1056-ZW	65711
Messing	528/1056mm	1108m	45mm	M4	VIE0657-1056-MES	65712



RISS mini greep aluminium

UITVOERING	BOORAFSTAND	OVERMETEN	HOOGTE	BEVESTIGING	ARTIKEL NR.	SNELCODE
Mat wit	192mm	207mm	39mm	M4	VIE0645-192-MW	64501
Mat zwart	192mm	207mm	39mm	M4	VIE0645-192-MZ	64502
Mos groen	192mm	207mm	39mm	M4	VIE0645-192-MG	64503
Woud groen	192mm	207mm	39mm	M4	VIE0645-192-WG	64504
Mokka bruin	192mm	207mm	39mm	M4	VIE0645-192-MB	64505
Vulkaan rood	192mm	207mm	39mm	M4	VIE0645-192-VR	64506
Nacht blauw	192mm	207mm	39mm	M4	VIE0645-192-BL	64507
Mat wit	320mm	335mm	39mm	M4	VIE0645-320-MW	64508
Mat zwart	320mm	335mm	39mm	M4	VIE0645-320-MZ	64509
Mos groen	320mm	335mm	39mm	M4	VIE0645-320-MG	64510
Woud groen	320mm	335mm	39mm	M4	VIE0645-320-WG	64511
Mokka bruin	320mm	335mm	39mm	M4	VIE0645-320-MB	64512
Vulkaan rood	320mm	335mm	39mm	M4	VIE0645-320-VR	64513
Nacht blauw	320mm	335mm	39mm	M4	VIE0645-320-BL	64514



RISS big greep aluminium

UITVOERING	BOORAFSTAND	OVERMETEN	HOOGTE	BEVESTIGING	ARTIKEL NR.	SNELCODE
Mat wit	480mm	502mm	52mm	M4	VIE0655-480-MW	65501
Mat zwart	480mm	502mm	52mm	M4	VIE0655-480-MZ	65502
Mos groen	480mm	502mm	52mm	M4	VIE0655-480-MG	65503
Woud groen	480mm	502mm	52mm	M4	VIE0655-480-WG	65504
Mokka bruin	480mm	502mm	52mm	M4	VIE0655-480-MB	65505
Vulkaan rood	480mm	502mm	52mm	M4	VIE0655-480-VR	65506
Nacht blauw	480mm	502mm	52mm	M4	VIE0655-480-BL	65507
Mat wit	480/960mm	982mm	52mm	M4	VIE0655-960-MW	65508
Mat zwart	480/960mm	982mm	52mm	M4	VIE0655-960-MZ	65509
Mos groen	480/960mm	982mm	52mm	M4	VIE0655-960-MG	65510
Woud groen	480/960mm	982mm	52mm	M4	VIE0655-960-WG	65511
Mokka bruin	480/960mm	982mm	52mm	M4	VIE0655-960-MB	65512
Vulkaan rood	480/960mm	982mm	52mm	M4	VIE0655-960-VR	65513
Nacht blauw	480/960mm	982mm	52mm	M4	VIE0655-960-BL	65514





GRAF BIG knop

UITVOERING	DIAMETER	HOOGTE	BEVESTIGING	ARTIKEL NR.	SNELCODE
Zwart	50mm	30mm	M4 vijs	VIE0486-50-ZW	48640
Messing	50mm	30mm	M4 vijs	VIE0486-50-MS	48641
Inox look	50mm	30mm	M4 vijs	VIE0486-50-IL	48643



GRAF MINI greep

UITVOERING	BOORAFSTAND	OVERMETEN	HOOGTE	BEVESTIGING	ARTIKEL NR.	SNELCODE
Zwart	160mm	182mm	33mm	M4	VIE430-182-ZW	43011
Messing	160mm	182mm	33mm	M4	VIE430-182-MS	43006
Inox look	160mm	182mm	33mm	M4	VIE430-182-IXL	43001
Zwart	256mm	278mm	33mm	M4	VIE430-278-ZW	43012
Messing	256mm	278mm	33mm	M4	VIE430-278-MS	43007
Inox look	256mm	278mm	33mm	M4	VIE430-278-IXL	43002

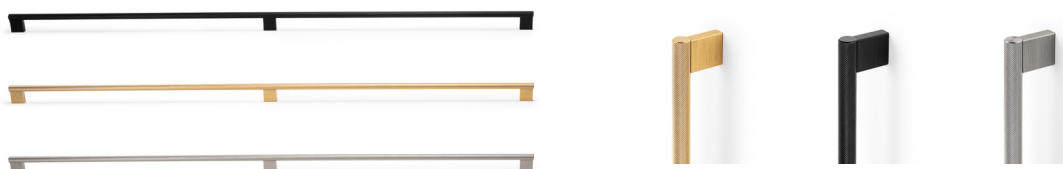

GRAF MINI greep met 3 steunen

UITVOERING	BOORAFSTAND	OVERMETEN	HOOGTE	BEVESTIGING	ARTIKEL NR.	SNELCODE
Zwart	589 / 1178mm	1200mm	33mm	M4	VIE430-1200-ZW	43013
Messing	589 / 1178mm	1200mm	33mm	M4	VIE430-1200-MS	43008
Inox look	589 / 1178mm	1200mm	33mm	M4	VIE430-1200-IXL	43003

Ook beschikbaar als kapstokhaak, zie pagina J 2.

Technische Fiche



NICK greep

UITVOERING	BOORAFSTAND	OVERMETEN	HOOGTE	BEVESTIGING	ARTIKEL NR.	SNELCODE
Inox look	32mm	50mm	24mm	M4	VIE0373-032-IL	37301
Koper geborsteld	32mm	50mm	24mm	M4	VIE0373-032-KOP	37302
Messing geborsteld	32mm	50mm	24mm	M4	VIE0373-032-MES	37303
Inox look	160mm	178mm	24mm	M4	VIE0373-160-IL	37304
Koper geborsteld	160mm	178mm	24mm	M4	VIE0373-160-KOP	37305
Messing geborstel	160mm	178mm	24mm	M4	VIE0373-160-MES	37306

Technische Fiche



REDO greep

UITVOERING	BOORAFSTAND	OVERMETEN	HOOGTE	BEVESTIGING	ARTIKEL NR.	SNELCODE
Brons antiek	128mm	137mm	32mm	M4	VIE0226-128-BA	22601
Inox look	128mm	137mm	32mm	M4	VIE0226-128-IL	22602
Koper geborsteld	128mm	137mm	32mm	M4	VIE0226-128-KOP	22603
Pewter (tin)	128mm	137mm	32mm	M4	VIE0226-128-PEW	22604
Brons antiek	192mm	201mm	32mm	M4	VIE0226-192-BA	22605
Inox look	192mm	201mm	32mm	M4	VIE0226-192-IL	22606
Koper geborsteld	192mm	201mm	32mm	M4	VIE0226-192-KOP	22607
Pewter (tin)	192mm	201mm	32mm	M4	VIE0226-192-PEW	22608

A MODERNE & KLASSIEKE GREPEN

Technische Fiche

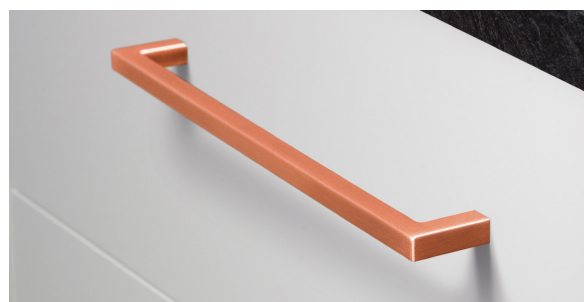

U greep

UITVOERING	BOORAFSTAND	OVERMETEN	HOOGTE	BEVESTIGING	ARTIKEL NR.	SNELCODE
Koper geborsteld	128mm	137mm	29mm	M4	VIE0056-128-MK	56001
Grijs geborsteld	128mm	137mm	29mm	M4	VIE0056-128-GG	56002
Messing geborsteld	128mm	137mm	29mm	M4	VIE0056-128-MES	56003
Inox look	128mm	137mm	29mm	M4	VIE0056-128-IL	56004
Chrome glans	128mm	137mm	29mm	M4	VIE0056-128-CHRGL	56005
Chrome mat	128mm	137mm	29mm	M4	VIE0056-128-CHRMA	56006
Mat wit	128mm	137mm	29mm	M4	VIE0056-128-WI	56007
Mat zwart	128mm	137mm	29mm	M4	VIE0056-128-ZW	56008

U greep

UITVOERING	BOORAFSTAND	OVERMETEN	HOOGTE	BEVESTIGING	ARTIKEL NR.	SNELCODE
Koper geborsteld	160mm	169mm	29mm	M4	VIE0056-160-MK	56009
Grijs geborsteld	160mm	169mm	29mm	M4	VIE0056-160-GG	56010
Messing geborsteld	160mm	169mm	29mm	M4	VIE0056-160-MES	56011
Inox look	160mm	169mm	29mm	M4	VIE0056-160-IL	56012
Chrome glans	160mm	169mm	29mm	M4	VIE0056-160-CHRGL	56013
Chrome mat	160mm	169mm	29mm	M4	VIE0056-160-CHRMA	56014
Mat wit	160mm	169mm	29mm	M4	VIE0056-160-WI	56015
Mat zwart	160mm	169mm	29mm	M4	VIE0056-160-ZW	56016

Koper geborsteld	192mm	201mm	29mm	M4	VIE0056-192-MK	56017
Grijs geborsteld	192mm	201mm	29mm	M4	VIE0056-192-GG	56018
Messing geborsteld	192mm	201mm	29mm	M4	VIE0056-192-MES	56019
Inox look	192mm	201mm	29mm	M4	VIE0056-192-IL	56020
Chrome glans	192mm	201mm	29mm	M4	VIE0056-192-CHRGL	56021
Chrome mat	192mm	201mm	29mm	M4	VIE0056-192-CHRMA	56022
Mat wit	192mm	201mm	29mm	M4	VIE0056-192-WI	56023
Mat zwart	192mm	201mm	29mm	M4	VIE0056-192-ZW	56024

Koper geborsteld	320mm	329mm	29mm	M4	VIE0056-320-MK	56025
Grijs geborsteld	320mm	329mm	29mm	M4	VIE0056-320-GG	56026
Messing geborsteld	320mm	329mm	29mm	M4	VIE0056-320-MES	56027
Inox look	320mm	329mm	29mm	M4	VIE0056-320-IL	56028
Chrome glans	320mm	329mm	29mm	M4	VIE0056-320-CHRGL	56029
Chrome mat	320mm	329mm	29mm	M4	VIE0056-320-CHRMA	56030
Mat wit	320mm	329mm	29mm	M4	VIE0056-320-WI	56031
Mat zwart	320mm	329mm	29mm	M4	VIE0056-320-ZW	56032

Koper geborsteld	492mm	501mm	29mm	M4	VIE0056-492-MK	56033
Grijs geborsteld	492mm	501mm	29mm	M4	VIE0056-492-GG	56034
Messing geborsteld	492mm	501mm	29mm	M4	VIE0056-492-MES	56035
Inox look	492mm	501mm	29mm	M4	VIE0056-492-IL	56036
Chrome glans	492mm	501mm	29mm	M4	VIE0056-492-CHRGL	56037
Chrome mat	492mm	501mm	29mm	M4	VIE0056-492-CHRMA	56038
Mat wit	492mm	501mm	29mm	M4	VIE0056-492-WI	56039
Mat zwart	492mm	501mm	29mm	M4	VIE0056-492-ZW	56040

A MODERNE & KLASSIEKE GREPEN

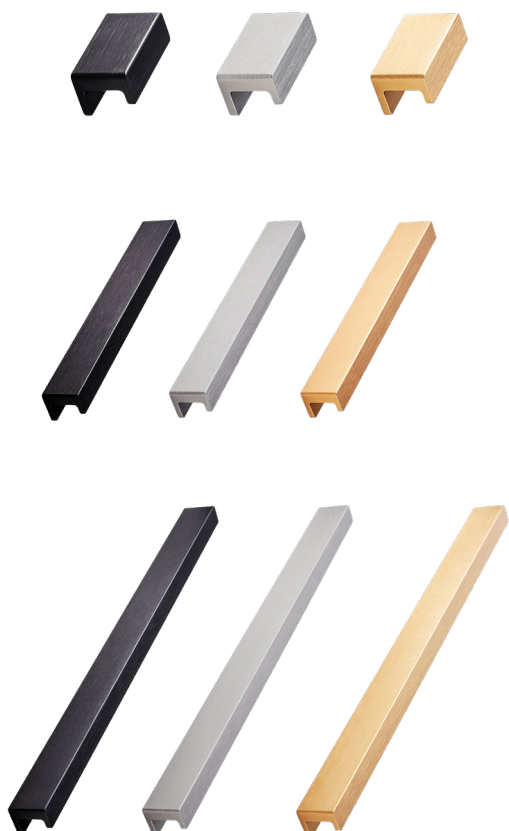

STATION greep

UITVOERING	BOORAFSTAND	OVERMETEN	HOOGTE	BEVESTIGING	ARTIKEL NR.	SNELCODE
Inox look	32mm	44mm	25mm	M4 vijs	0706FP437-032IL	43701
Mat messing	32mm	44mm	25mm	M4 vijs	0706FP437-032MM	43702
Mat zwart	32mm	44mm	25mm	M4 vijs	0706FP437-032ZW	43703
Inox look	160mm	190mm	25mm	M4 vijs	0706FP437-160IL	43704
Mat messing	160mm	190mm	25mm	M4 vijs	0706FP437-160MM	43705
Mat zwart	160mm	190mm	25mm	M4 vijs	0706FP437-160ZW	43706
Inox look	320mm	350mm	25mm	M4 vijs	0706FP437-320IL	43707
Mat messing	320mm	350mm	25mm	M4 vijs	0706FP437-320MM	43708
Mat zwart	320mm	350mm	25mm	M4 vijs	0706FP437-320ZW	43709

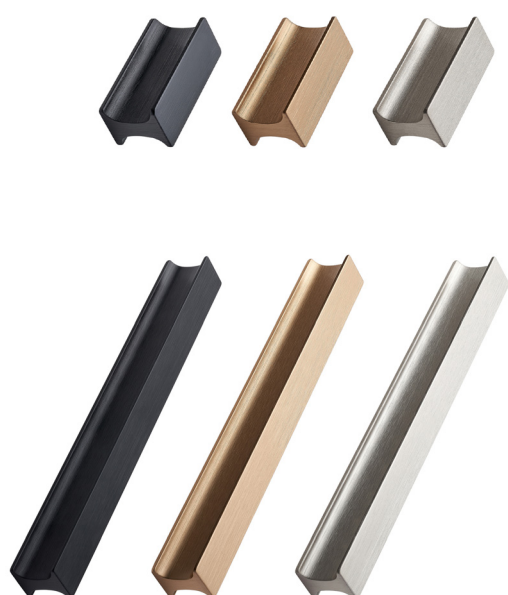

TRACK knop

UITVOERING	BOORAFSTAND	OVERMETEN	HOOGTE	BEVESTIGING	ARTIKEL NR.	SNELCODE
Messing geborsteld	32mm	50mm	24mm	M4	0706FP45702-32-MES	45710
Inox look	32mm	50mm	24mm	M4	0706FP45702-32-IL	45711
Mat zwart	32mm	50mm	24mm	M4	0706FP45702-32-ZW	45712

TRACK greep

UITVOERING	BOORAFSTAND	OVERMETEN	HOOGTE	BEVESTIGING	ARTIKEL NR.	SNELCODE
Messing geborsteld	160mm	200mm	24mm	M4	0706FP45702-160-MES	45701
Inox look	160mm	200mm	24mm	M4	0706FP45702-160-IL	45702
Mat zwart	160mm	200mm	24mm	M4	0706FP45702-160-ZW	45703



MANOR
COLLECTION



MANOR greep

UITVOERING	BOORAFSTAND	OVERMETEN	HOOGTE	BEVESTIGING	ARTIKEL NR.	SNELCODE
Brons antiek	128mm	182mm	36mm	M4 vijs	0706FP548-128BA	54801
Goud	128mm	182mm	36mm	M4 vijs	0706FP548-128GO	54910
Mat zwart	128mm	182mm	36mm	M4 vijs	0706FP548-128ZW	54802
Brons antiek	192mm	246mm	36mm	M4 vijs	0706FP548-192BA	54803
Goud	192mm	246mm	36mm	M4 vijs	0706FP548-192GO	54911
Mat zwart	192mm	246mm	36mm	M4 vijs	0706FP548-192ZW	54804

A MODERNE & KLASSIEKE GREPEN



MANOR greep met plaat

UITVOERING	BOORAFSTAND	OVERMETEN	HOOGTE	BEVESTIGING	ARTIKEL NR.	SNELCODE
Brons antiek	128mm	190mm	39mm	M4 vijs	0706FP549-128BA	54901
Goud	128mm	190mm	39mm	M4 vijs	0706FP549-128GO	54912
Mat zwart	128mm	190mm	39mm	M4 vijs	0706FP549-128ZW	54902
Brons antiek	192mm	254mm	39mm	M4 vijs	0706FP549-192BA	54903
Goud	192mm	254mm	39mm	M4 vijs	0706FP549-192GO	54913
Mat zwart	192mm	254mm	39mm	M4 vijs	0706FP549-192ZW	54904

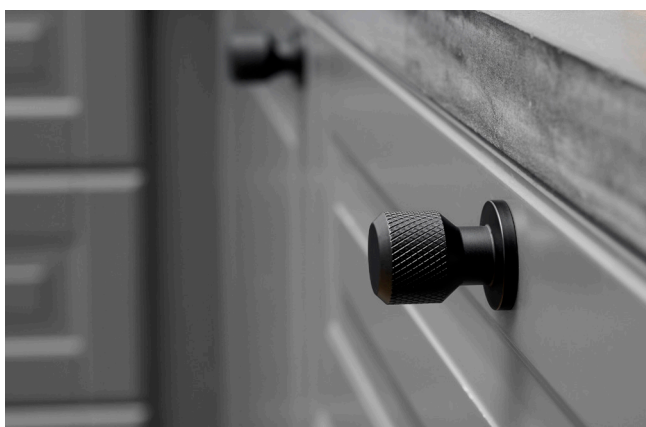

MANOR ROUND knop

UITVOERING	DIAMETER	HOOGTE	BEVESTIGING	ARTIKEL NR.	SNELCODE
Brons antiek	30mm	35mm	M4 vijs	0706FP549-25BA	54907
Goud	30mm	35mm	M4 vijs	0706FP549-25GO	54914
Mat zwart	30mm	35mm	M4 vijs	0706FP549-25ZW	54908

MANOR T-knop

UITVOERING	OVERMETEN	HOOGTE	BEVESTIGING	ARTIKEL NR.	SNELCODE
Brons antiek	54mm	39mm	M4 vijs	0706FP549-54BA	54905
Goud	54mm	39mm	M4 vijs	0706FP549-54GO	54915
Mat zwart	54mm	39mm	M4 vijs	0706FP549-54ZW	54906

A MODERNE & KLASSIEKE GREPEN



SQUARE greep inox 14 x 14mm

BOORAFSTAND	OVERMETEN	HOOGTE	DIAMETER	BEVESTIGING	ARTIKEL NR.	SNELCODE
160mm	174mm	42mm	14x14mm	M4 vijs	0706FP231037160	01011
192mm	206mm	42mm	14x14mm	M4 vijs	0706FP231037192	02011
224mm	238mm	42mm	14x14mm	M4 vijs	0706FP231037224	03011
320mm	334mm	42mm	14x14mm	M4 vijs	0706FP231037320	04011
448mm	462mm	42mm	14x14mm	M4 vijs	0706FP231037448	05011
512mm	526mm	42mm	14x14mm	M4 vijs	0706FP231037512	06011



SQUARE greep alu 10 x 10mm

UITVOERING	BOORAFSTAND	OVERMETEN	HOOGTE	BEVESTIGING	ARTIKEL NR.	SNELCODE
Antraciet grijs	128mm	138mm	32mm	M4 vijs	0706FP4350128AN	01065
Inox look	128mm	138mm	32mm	M4 vijs	0706FP4350128IL	02065
Messing	128mm	138mm	32mm	M4 vijs	0706FP4350128ME	03065
Geborsteld zwart	128mm	138mm	32mm	M4 vijs	0706FP4350128ZW	04065

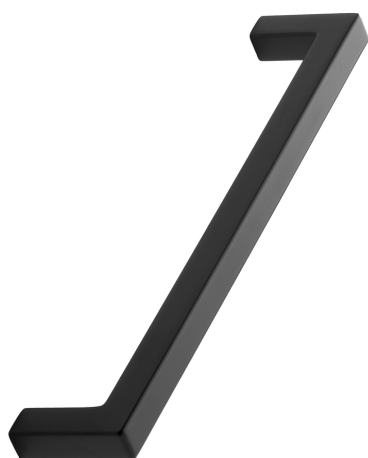

Ook beschikbaar
in de ecologische
oceanix-versie!
(zie volgende pagina)



SQUARE greep zamak 10 x 10mm

UITVOERING	BOORAFSTAND	OVERMETEN	HOOGTE	BEVESTIGING	ARTIKEL NR.	SNELCODE
Mat zwart	128mm	138mm	32mm	M4 vijs	0706FP51036-128-ZW	51036
Mat zwart	160mm	170mm	32mm	M4 vijs	0706FP51036-160-ZW	51037
Mat zwart	224mm	234mm	32mm	M4 vijs	0706FP51036-224-ZW	51038
Mat zwart	320mm	330mm	32mm	M4 vijs	0706FP51036-320-ZW	51039
Mat zwart	448mm	458mm	32mm	M4 vijs	0706FP51036-448-ZW	51040

Oceanix

Knoppen & grepen gemaakt uit gerecycleerd maritiem afval

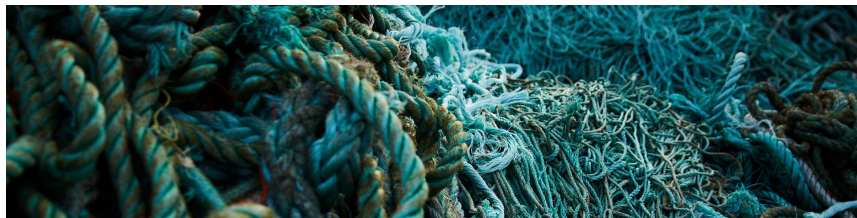

De oceanen hebben steeds meer te kampen met het probleem van kapotte sleepnetten, puin en andere soorten plastic materiaal. Het grootste deel van deze vervuiling is te wijten aan een slechte verwerking van afval aan land. Dit resulteert helaas in een opeenhoping van plastic zowel aan land als in de oceanen. Wanneer dit plastic niet wordt ingezameld of hergebruikt, moet er voortdurend nieuw plastic worden geproduceerd, wat zich vertaalt in het gewin van fossiele materialen.

PLASTIX ontvangt het ingezamelde materiaal en na een reinigingsproces wordt het plastic omgezet in gegranuleerd plastic dat tot nieuwe producten kan worden gevormd. De knoppen en grepen van Furnipart (zie rechts) worden in dit materiaal gegoten bij PLASTIX. Zodra de knoppen en handgrepen zijn gegoten en de kwaliteit ervan is geverifieerd, worden ze verpakt in biologisch afbreekbare plastic zakken.

Kortom, het gebruik van dit materiaal zorgt voor minder afval en een reductie van de CO₂ uitstoot die het aanmaken van nieuw plastic veroorzaakt.

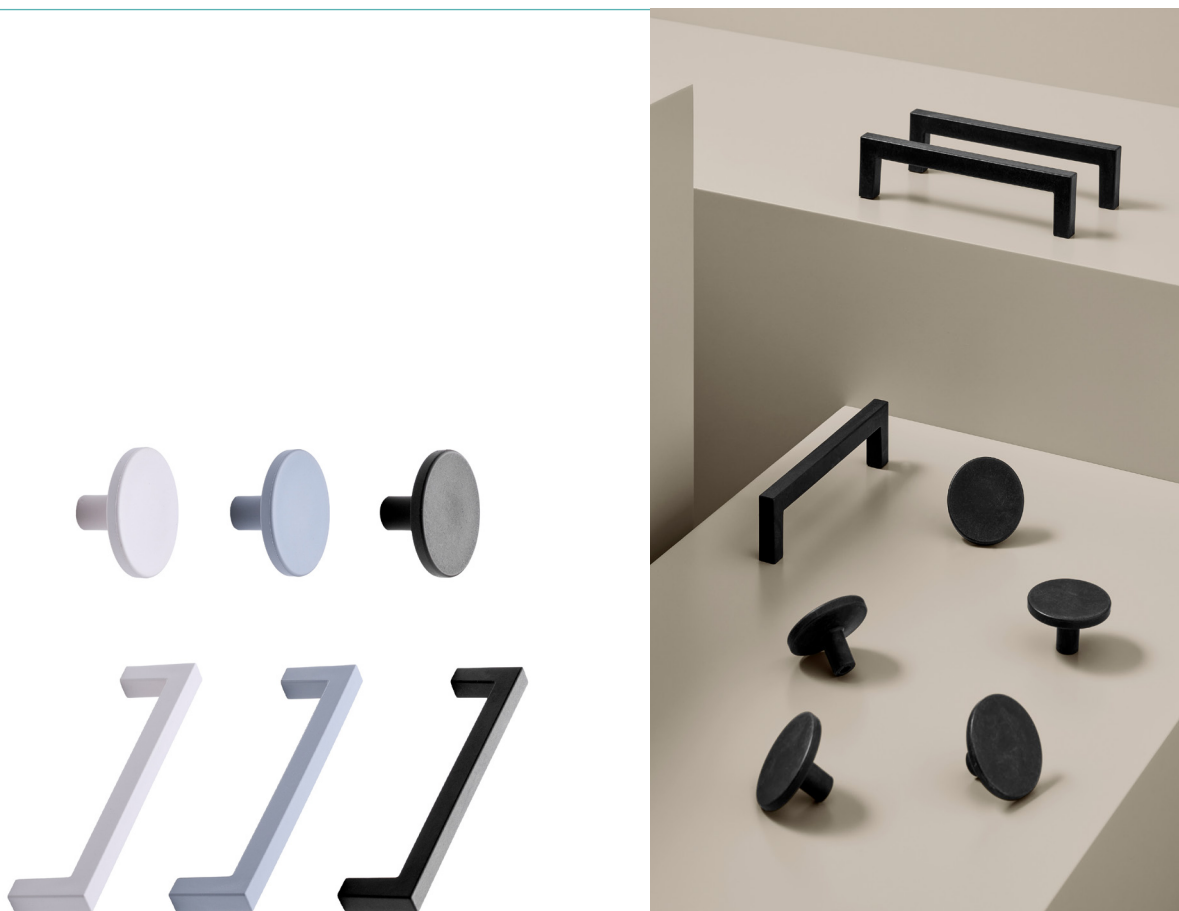

PLATO OCEANIX knop

UITVOERING	DIAMETER	HOOGTE	BEVESTIGING	ARTIKEL NR.	SNELCODE
Beige	42mm	24mm	Houtvijs (inbegrepen)	0706FP70001-42-BEI	70007
Grijs	42mm	24mm	Houtvijs (inbegrepen)	0706FP70001-42-GR	70006
Zwart	42mm	24mm	Houtvijs (inbegrepen)	0706FP70001-42-ZW	70005

SQUARE 10mm OCEANIX greep

UITVOERING	BOORAFSTAND	OVERMETEN	HOOGTE	BEVESTIGING	ARTIKEL NR.	SNELCODE
Beige	128mm	138mm	32mm	Houtvijzen (inbegrepen)	0706FP70002-128-BEI	70004
Grijs	128mm	138mm	32mm	Houtvijzen (inbegrepen)	0706FP70002-128-GR	70003
Zwart	128mm	138mm	32mm	Houtvijzen (inbegrepen)	0706FP70002-128-ZW	70002

A MODERNE & KLASSIEKE GREPEN



PILLAR knop & greep mat zwart

ARTIKEL	BOORAFSTAND	OVERMETEN	HOOGTE	BEVESTIGING	ARTIKEL NR.	SNELCODE
Knop	/	15mm	33mm	M4 vijs	0706FP547772-99	54773
Greep	160mm	175mm	33mm	M4 vijs	0706FP547620.99	54763

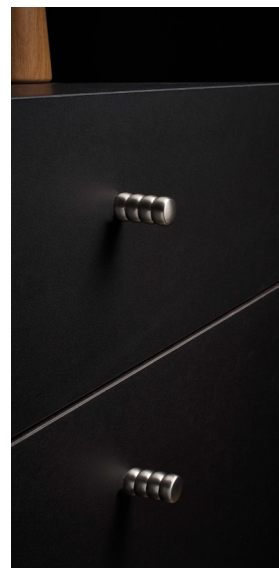
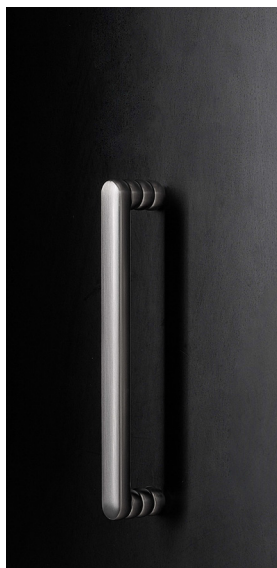
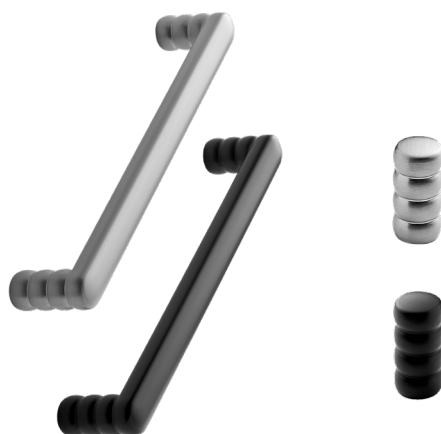

BOUNCE knop & greep

ARTIKEL	UITVOERING	BOORAFSTAND	OVERMETEN	HOOGTE	BEVESTIGING	ARTIKEL NR.	SNELCODE
Knop	inox look	/	16mm	34mm	M4 vijs	0706FP54676.66	54676
Greep	inox look	160mm	176mm	33mm	M4 vijs	0706FP54666.66	54666
Knop	mat zwart	/	16mm	34mm	M4 vijs	0706FP54676.99	54677
Greep	mat zwart	160mm	176mm	33mm	M4 vijs	0706FP54666.99	54660



FLOID knop

UITVOERING	DIAMETER	HOOGTE	BEVESTIGING	ARTIKEL NR.	SNELCODE
Mat zwart	35mm	30mm	M4 vijs	VIE0495-35-ZW	49535
Geborsteld goud	35mm	30mm	M4 vijs	VIE0495-35-GO	49536

FLOID greep

UITVOERING	BOORAFSTAND	OVERMETEN	HOOGTE	BEVESTIGING	ARTIKEL NR.	SNELCODE
Mat zwart	192mm	208mm	31mm	M4 vijs	VIE0495-192-ZW	49537
Geborsteld goud	192mm	208mm	31mm	M4 vijs	VIE0495-192-GO	49538

A MODERNE & KLASSIEKE GREPEN

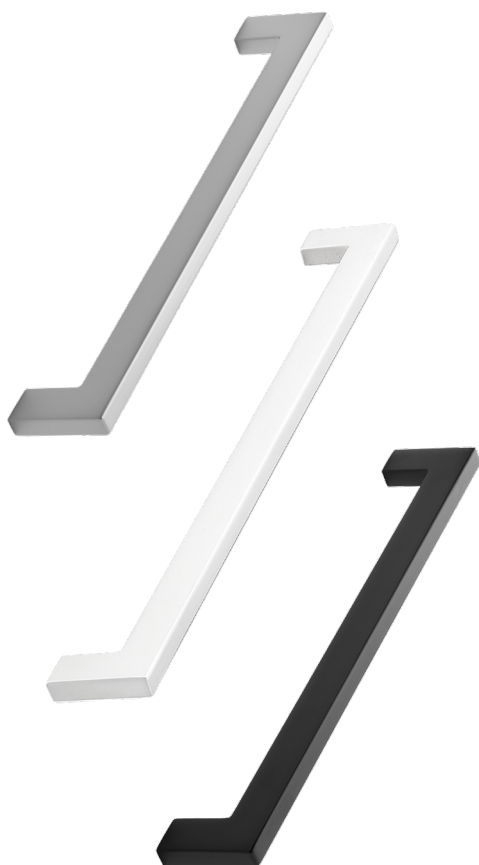

FLAT greep

UITVOERING	BOORAFSTAND	OVERMETEN	HOOGTE	DIAMETER	BEVESTIGING	ARTIKEL NR.	SNELCODE
Zwart RAL9005	128mm	142mm	33mm	8mm	M4 vijs	0706FP51286-128Z	51128
Zwart RAL9005	192mm	206mm	33mm	8mm	M4 vijs	0706FP51286-192Z	51192
Zwart RAL9005	256mm	270mm	33mm	8mm	M4 vijs	0706FP51286-256Z	51256
Zwart RAL9005	448mm	462mm	33mm	8mm	M4 vijs	0706FP51286-448Z	51448
Wit RAL9010	128mm	142mm	33mm	8mm	M4 vijs	0706W512860128	37355
Inox look	128mm	142mm	33mm	8mm	M4 vijs	0706FP512860128	01047
Inox look	192mm	206mm	33mm	8mm	M4 vijs	0706FP512860192	02047
Inox look	256mm	270mm	33mm	8mm	M4 vijs	0706FP512860256	03047
Inox look	448mm	462mm	33mm	8mm	M4 vijs	0706FP512860448	04047



D-LITE greep klein

UITVOERING	BOORAFSTAND	OVERMETEN	HOOGTE	BEVESTIGING	ARTIKEL NR.	SNELCODE
Glanzend nikkel	32mm	44mm	32mm	M4 vijs	0706FP5521032GN	55211
Goud	32mm	44mm	32mm	M4 vijs	0706FP5521032GO	55212
Mat zwart	32mm	44mm	32mm	M4 vijs	0706FP5521032MZ	55213



D-LITE greep groot

UITVOERING	BOORAFSTAND	OVERMETEN	HOOGTE	BEVESTIGING	ARTIKEL NR.	SNELCODE
Glanzend nikkel	160mm	172mm	32mm	M4 vijs	0706FP5521160GN	55214
Goud	160mm	172mm	32mm	M4 vijs	0706FP5521160GO	55215
Mat zwart	160mm	172mm	32mm	M4 vijs	0706FP5521160MZ	55216

A MODERNE & KLASSIEKE GREPEN



SCOPE knop & greep

UITVOERING	BOORAFSTAND	OVERMETEN	HOOGTE	DIAMETER	BEVESTIGING	ARTIKEL NR.	SNELCODE
Inox look	/	20mm	30mm	16mm	M4 vijs	0706FP543KN-IL	04034
Zwart	/	20mm	30mm	16mm	M4 vijs	0706FP543KN-ZW	05034
Inox look	160mm	176mm	36mm	16mm	M4 vijs	0706FP543GR-IL	06034
Zwart	160mm	176mm	36mm	16mm	M4 vijs	0706FP543GR-ZW	07034

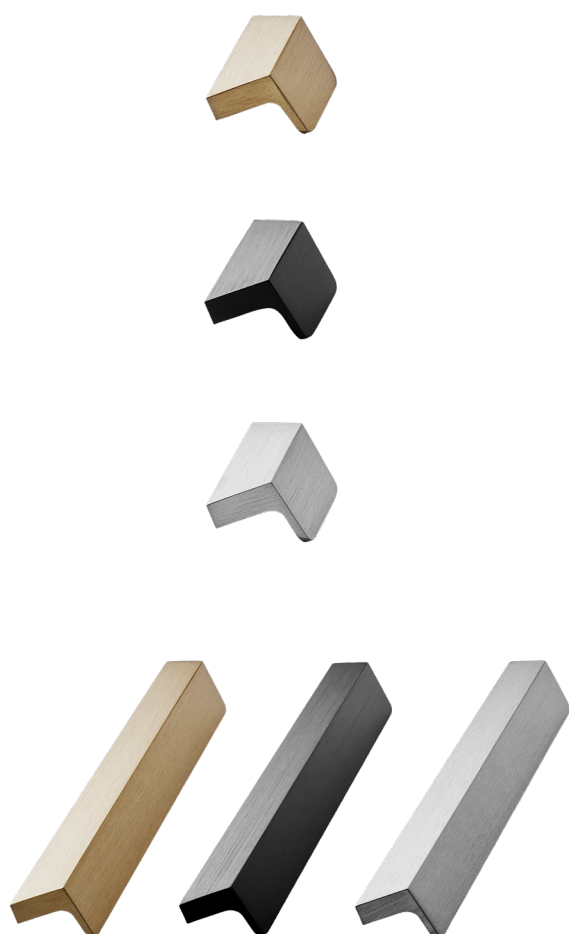

ENVELOPE greep

UITVOERING	BOORAFSTAND	OVERMETEN	HOOGTE	BEVESTIGING	ARTIKEL NR.	SNELCODE
Geborsteld goud	32mm	50mm	25mm	M4 vijs	0706FP449-32-GO	44932
Mat zwart	32mm	50mm	25mm	M4 vijs	0706FP449-32-ZW	44933
Inox look	32mm	50mm	25mm	M4 vijs	0706FP449-32-IL	44934
Geborsteld goud	160mm	200mm	24mm	M4 vijs	0706FP449-160-G	44935
Mat zwart	160mm	200mm	24mm	M4 vijs	0706FP449-160-Z	44936
Inox look	160mm	200mm	24mm	M4 vijs	0706FP449-160-I	44937

A MODERNE & KLASSIEKE GREPEN



REGULAR 2 greep

UITVOERING	BOORAFSTAND	OVERMETEN	HOOGTE	DIAMETER	BEVESTIGING	ARTIKEL NR.	SNELCODE
Inox	192mm	206mm	40mm	13mm	M4 vijs	0706FP240192-IN	03044
Zwart	192mm	206mm	40mm	13mm	M4 vijs	0706FP240192-ZW	04044



BIG greep inox

BOORAFSTAND	OVERMETEN	HOOGTE	DIAMETER	BEVESTIGING	ARTIKEL NR.	SNELCODE
160mm	172mm	45mm	22mm	M4 vijs	0706FP224330160	01013
192mm	204mm	45mm	22mm	M4 vijs	0706FP224330192	02013
256mm	268mm	45mm	22mm	M4 vijs	0706FP224330256	03013
320mm	332mm	45mm	22mm	M4 vijs	0706FP224330320	04013
448mm	460mm	45mm	22mm	M4 vijs	0706FP224330448	05013



CUT greep inox look

BOORAFSTAND	OVERMETEN	HOOGTE	BEVESTIGING	ARTIKEL NR.	SNELCODE
160mm	175mm	20mm	M4 vijs	0706FP4082160IL	01043

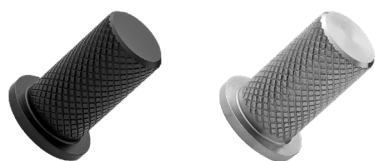

HARLEQUIN knop

UITVOERING	HOOGTE	DIAMETER	BEVESTIGING	ARTIKEL NR.	SNELCODE
Inox	33mm	17mm	M4 vijs	0706FP240717-IN	05044
Zwart	33mm	17mm	M4 vijs	0706FP240717-ZW	06044

A MODERNE & KLASSIEKE GREPEN



SENSE greep geborsteld zwart

BOORAFSTAND	OVERMETEN	HOOGTE	BEVESTIGING	ARTIKEL NR.	SNELCODE
128mm	135mm	30mm	M4 vijs	VIE0195-128-ZW	19501
192mm	199mm	30mm	M4 vijs	VIE0195-192-ZW	19502
320mm	327mm	30mm	M4 vijs	VIE0195-320-ZW	19503
480mm	487mm	30mm	M4 vijs	VIE0195-480-ZW	19504



Lounge greep

UITVOERING	BOORAFSTAND	OVERMETEN	HOOGTE	BEVESTIGING	ARTIKEL NR.	SNELCODE
Messing	160mm	174mm	35mm	M4 vijs	0706FP240330-29	24033
Zwart	160mm	174mm	35mm	M4 vijs	0706FP240330-95	24034



ESTE greep

UITVOERING	BOORAFSTAND	OVERMETEN	HOOGTE	BEVESTIGING	ARTIKEL NR.	SNELCODE
Messing	160mm	172mm	30mm	M4 vijs	VIE446-160-MS	44602
Inox look	160mm	172mm	30mm	M4 vijs	VIE446-160-IL	44601
Mat zwart	160mm	172mm	30mm	M4 vijs	VIE446-160-ZW	44603

A MODERNE & KLASSIEKE GREPEN



BOSTON greep inox

BOORAFSTAND	OVERMETEN	HOOGTE	DIAMETER	BEVESTIGING	ARTIKEL NR.	SNELCODE
96mm	118mm	34mm	12mm	M4 vijs	0706GR012100961	01014
128mm	150mm	34mm	12mm	M4 vijs	0706GR012101281	02014
160mm	182mm	34mm	12mm	M4 vijs	0706GR012101601	03014
192mm	214mm	34mm	12mm	M4 vijs	0706GR012101921	04014
224mm	246mm	34mm	12mm	M4 vijs	0706GR012102241	05014
256mm	278mm	34mm	12mm	M4 vijs	0706GR012102561	06014
288mm	310mm	34mm	12mm	M4 vijs	0706GR012102881	07014
320mm	342mm	34mm	12mm	M4 vijs	0706GR012103201	08014
352mm	374mm	34mm	12mm	M4 vijs	0706GR012103521	09014
448mm	470mm	34mm	12mm	M4 vijs	0706GR012104481	10014
480mm	502mm	34mm	12mm	M4 vijs	0706GR012104801	11014



SMOOTH greep aluminium inox look

BOORAFSTAND	OVERMETEN	HOOGTE	DIAMETER	BEVESTIGING	ARTIKEL NR.	SNELCODE
160mm	168mm	26mm	20mm	M4 vijs	0706GR08642519	04038



FUNK greep inox look

BOORAFSTAND	OVERMETEN	DIAMETER	BEVESTIGING	ARTIKEL NR.	SNELCODE
192mm	216mm	14mm	M4 vijs	0706GR08228617	06030



T-greep inox look diam.12mm/10mm

BOORAFSTAND	OVERMETEN	HOOGTE	DIAMETER	BEVESTIGING	ARTIKEL NR.	SNELCODE
96mm	156mm	32mm	12mm/10mm	M4 vijs	0706GR852521096	01004
128mm	188mm	32mm	12mm/10mm	M4 vijs	0706GR852521128	02004
160mm	220mm	32mm	12mm/10mm	M4 vijs	0706GR852521160	03004
192mm	252mm	32mm	12mm/10mm	M4 vijs	0706GR852521192	04004
224mm	284mm	32mm	12mm/10mm	M4 vijs	0706GR852521224	05004
256mm	316mm	32mm	12mm/10mm	M4 vijs	0706GR852521256	06004
288mm	348mm	32mm	12mm/10mm	M4 vijs	0706GR852521288	07004
320mm	380mm	32mm	12mm/10mm	M4 vijs	0706GR852521320	08004
352mm	412mm	32mm	12mm/10mm	M4 vijs	0706GR852521352	09004
384mm	444mm	32mm	12mm/10mm	M4 vijs	0706GR852521384	10004
448mm	508mm	32mm	12mm/10mm	M4 vijs	0706GR852521448	11004
480mm	540mm	32mm	12mm/10mm	M4 vijs	0706GR852521480	12004
511mm	571mm	32mm	12mm/10mm	M4 vijs	0706GR852521511	13004
576mm	636mm	32mm	12mm/10mm	M4 vijs	0706GR852521576	14004
640mm	690mm	32mm	12mm/10mm	M4 vijs	0706GR852521640	15004
736mm	796mm	32mm	12mm/10mm	M4 vijs	0706GR852521736	16004
884mm	944mm*	32mm	12mm/10mm	M4 vijs	0706GR852531108	17004
1136mm	1196mm*	32mm	12mm/10mm	M4 vijs	0706GR852531136	19004

* = 3 steunen in plaats van 2

INOX



T-greep inox diam.12mm/10mm

BOORAFSTAND	OVERMETEN	HOOGTE	DIAMETER	BEVESTIGING	ARTIKEL NR.	SNELCODE
96mm	146mm	32mm	12mm/10mm	M4 vijs	0706BM2230.096	01001
128mm	178mm	32mm	12mm/10mm	M4 vijs	0706BM2230.128	02001
160mm	210mm	32mm	12mm/10mm	M4 vijs	0706BM2230.160	03001
192mm	242mm	32mm	12mm/10mm	M4 vijs	0706BM2230.192	04001
224mm	274mm	32mm	12mm/10mm	M4 vijs	0706BM2230.224	05001
288mm	338mm	32mm	12mm/10mm	M4 vijs	0706BM2230.288	07001
352mm	402mm	32mm	12mm/10mm	M4 vijs	0706BM2230.352	09001
384mm	434mm	32mm	12mm/10mm	M4 vijs	0706BM2230.384	10001
448mm	498mm	32mm	12mm/10mm	M4 vijs	0706BM2230.448	12001
544mm	594mm	32mm	12mm/10mm	M4 vijs	0706BM2230.544	15001

A MODERNE & KLASSIEKE GREPEN



T-greep inox met bijhorende knoppen

BOORAFSTAND	OVERMETEN	HOOGTE	DIAMETER	BEVESTIGING	ARTIKEL NR.	SNELCODE
/	/	22mm	13mm	M4 vijs	0706V8922 031	04005
/	/	26mm	18mm	M4 vijs	0706V8921 031	05005
96mm	132mm	28mm	10mm	M4 vijs	0706V7923 031	01005
128mm	166mm	28mm	10mm	M4 vijs	0706V7922 031	02005
160mm	200mm	28mm	10mm	M4 vijs	0706V7921 031	03005



T-greep zwart

BOORAFSTAND	OVERMETEN	HOOGTE	DIAMETER	BEVESTIGING	ARTIKEL NR.	SNELCODE
128mm	188mm	32mm	12mm	M4 vijs	0706ZW8525-128	85128
160mm	220mm	32mm	12mm	M4 vijs	0706ZW8525-160	85160
192mm	252mm	32mm	12mm	M4 vijs	0706ZW8525-192	85192
320mm	380mm	32mm	12mm	M4 vijs	0706ZW8525-320	85320



BOW greep

UITVOERING	BOORAFSTAND	DIAMETER	BEVESTIGING	ARTIKEL NR.	SNELCODE
Inox	96mm	10mm	M4 vijs	0706BM2270.096	01007
Inox	128mm	10mm	M4 vijs	0706BM2270.128	02007
Inox	160mm	10mm	M4 vijs	0706BM2270.160	03007
Inox	192mm	10mm	M4 vijs	0706BM2270.192	04007
Zwart	96mm	10mm	M4 vijs	0706ZW7214-096	73096
Zwart	128mm	10mm	M4 vijs	0706ZW7214-128	73128
Zwart	160mm	10mm	M4 vijs	0706ZW7214-160	73160
Zwart	192mm	10mm	M4 vijs	0706ZW7214-192	73192
Zwart	320mm	10mm	M4 vijs	0706ZW7214-320	73320



Banaan greep

UITVOERING	BOORAFSTAND	DIAMETER	BEVESTIGING	ARTIKEL NR.	SNELCODE
Inox	96mm	9mm	M4 vijs	0706V7862 031	07007
Wit	96mm	9mm	M4 vijs	0706V7862 002	08007
Zwart	96mm	9mm	M4 vijs	0706V7862 033	09007
Goud	96mm	9mm	M4 vijs	0706V7862 100	10007
Chromé glans	96mm	9mm	M4 vijs	0706V7862 400	11007
Inox	128mm	10mm	M4 vijs	0706V7861 031	12007
Wit	128mm	10mm	M4 vijs	0706V7861 002	13007
Zwart mat	128mm	10mm	M4 vijs	0706V7861 032	14007
Goud	128mm	10mm	M4 vijs	0706V7861 100	15007

A MODERNE & KLASSIEKE GREPEN



BEUGEL greep inox

BOORAFSTAND	OVERMETEN	HOOGTE	DIAMETER	BEVESTIGING	ARTIKEL NR.	SNELCODE
96mm	106mm	35mm	10mm	M4 vijs	0706GR72214317	07006
128mm	138mm	35mm	10mm	M4 vijs	0706GR72214417	08006
160mm	170mm	35mm	10mm	M4 vijs	0706GR72214517	09006
192mm	202mm	35mm	10mm	M4 vijs	0706GR72214617	10006
224mm	234mm	35mm	10mm	M4 vijs	0706GR72214717	11006
288mm	298mm	35mm	10mm	M4 vijs	0706GR72214917	12006
320mm	330mm	35mm	10mm	M4 vijs	0706GR72215017	13006
448mm	458mm	35mm	10mm	M4 vijs	0706GR72215217	14006
512mm	522mm	35mm	10mm	M4 vijs	0706GR72126117	15006

BEUGEL greep zwart

BOORAFSTAND	OVERMETEN	HOOGTE	DIAMETER	BEVESTIGING	ARTIKEL NR.	SNELCODE
96mm	106mm	32mm	10mm	M4 vijs	0706ZW7213-096	72096
128mm	138mm	32mm	10mm	M4 vijs	0706ZW7213-128	72128
160mm	170mm	32mm	10mm	M4 vijs	0706ZW7213-160	72160
192mm	202mm	32mm	10mm	M4 vijs	0706ZW7213-192	72192



APO greep aluminium

BOORAFSTAND	OVERMETEN	HOOGTE	DIAMETER	BEVESTIGING	ARTIKEL NR.	SNELCODE
128mm	136mm	35mm	28mm	M4 vijs	0706GR08811447	01029
160mm	168mm	35mm	28mm	M4 vijs	0706GR08811547	02029
192mm	200mm	35mm	28mm	M4 vijs	0706GR08811647	03029



SOFIA greep inox look

BOORAFSTAND	OVERMETEN	DIAMETER	BEVESTIGING	ARTIKEL NR.	SNELCODE
128mm	144mm	16mm	M4 vijs	0706GR08594419	03046

A MODERNE & KLASSIEKE GREPEN

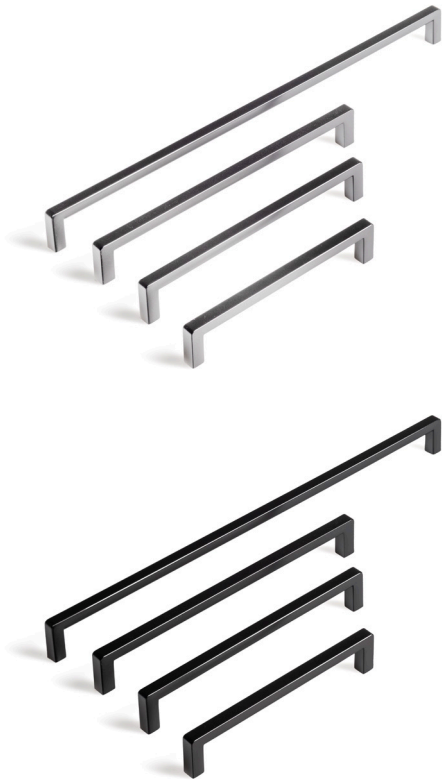

THIN greep inox look

BOORAFSTAND	OVERMETEN	HOOGTE	DIAMETER	BEVESTIGING	ARTIKEL NR.	SNELCODE
96mm	104mm	28mm	9mm	M4 vijs	0706GR08941319	02031
128mm	136mm	28mm	9mm	M4 vijs	0706GR08941419	03031
160mm	168mm	28mm	9mm	M4 vijs	0706GR08941519	04031
192mm	200mm	28mm	9mm	M4 vijs	0706GR08941619	05031
320mm	328mm	28mm	9mm	M4 vijs	0706GR08942019	06031
448mm	456mm	28mm	9mm	M4 vijs	0706GR08942319	07031

THIN greep mat zwart gelakt

BOORAFSTAND	OVERMETEN	HOOGTE	DIAMETER	BEVESTIGING	ARTIKEL NR.	SNELCODE
96mm	104mm	28mm	9mm	M4 vijs	0706GR089413ZW	08031
128mm	136mm	28mm	9mm	M4 vijs	0706GR089414ZW	09031
160mm	168mm	28mm	9mm	M4 vijs	0706GR089415ZW	10031
192mm	200mm	28mm	9mm	M4 vijs	0706GR089416ZW	11031
320mm	328mm	28mm	9mm	M4 vijs	0706GR089420ZW	12031



CURVE greep zamak chromé mat

BOORAFSTAND	OVERMETEN	DIAMETER	BEVESTIGING	ARTIKEL NR.	SNELCODE
32mm	87mm	22mm	M4 vijs	0706GR08656131	01032

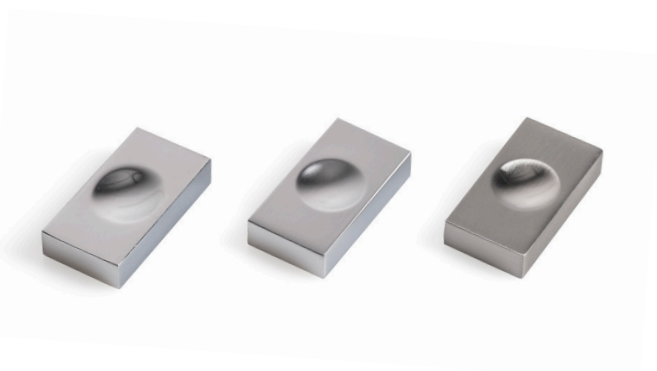

MILAN greep zamak

UITVOERING	BOORAFSTAND	OVERMETEN	HOOGTE	BEVESTIGING	ARTIKEL NR.	SNELCODE
Chromé glans	32mm	42mm	22mm	M4 vijs	0706GR08840029	02032
Chromé mat	32mm	42mm	22mm	M4 vijs	0706GR08840030	03032
Inox look	32mm	42mm	22mm	M4 vijs	0706GR08840019	04032

A MODERNE & KLASSIEKE GREPEN



BALK greep aluminium

BOORAFSTAND	OVERMETEN	DIAMETER	BEVESTIGING	ARTIKEL NR.	SNELCODE
128mm	146mm	12mm	M4 vijs	0706GR083324471	01027
192mm	210mm	12mm	M4 vijs	0706GR083326471	02027
320mm	338mm	12mm	M4 vijs	0706GR083330471	03027

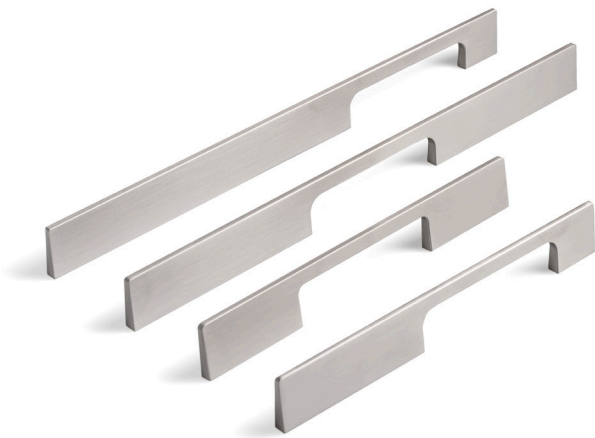

ANTVERPIA greep aluminium inox look

BOORAFSTAND	OVERMETEN	UITVOERING	DIAMETER	BEVESTIGING	ARTIKEL NR.	SNELCODE
192mm	224mm	Uit het midden	8mm	M4 vijs	0706GR854721921	01040
192mm	224mm	Gecentreerd	8mm	M4 vijs	0706GR85472192	02040
160/320mm	352mm	Uit het midden	8mm	M4 vijs	0706GR854733201	03040
224/320mm	352mm	Gecentreerd	8mm	M4 vijs	0706GR85474320	04040



SOLID greep inox

BOORAFSTAND	OVERMETEN	HOOGTE	DIAMETER	BEVESTIGING	ARTIKEL NR.	SNELCODE
160mm	173mm	38mm	25mm	M4 vijs	0706V7506 031	04036
192mm	205mm	38mm	25mm	M4 vijs	0706V7505 031	05036
224mm	237mm	38mm	25mm	M4 vijs	0706V7504 031	06036
256mm	269mm	38mm	25mm	M4 vijs	0706V7503 031	07036
288mm	301mm	38mm	25mm	M4 vijs	0706V7502 031	08036
320mm	333mm	38mm	25mm	M4 vijs	0706V7501 031	09036

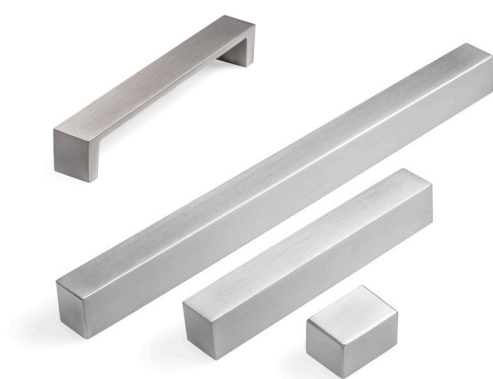

CUBE greep aluminium inox look

BOORAFSTAND	OVERMETEN	HOOGTE	DIAMETER	BEVESTIGING	ARTIKEL NR.	SNELCODE
32mm	42mm	28mm	25mm	M4 vijs	0706GR08903119	03039
160mm	170mm	28mm	25mm	M4 vijs	0706GR08903519	05039
320mm	330mm	28mm	25mm	M4 vijs	0706GR08904019	06039

A

MODERNE & KLASSIEKE GREPEN



FOLD greep aluminium inox look

BOORAFSTAND	OVERMETEN	DIAMETER	BEVESTIGING	ARTIKEL NR.	SNELCODE
160mm	226mm	20mm	M4 vijs	0706GR08589619	01038



SALONIKI greep mat vernikkeld

BOORAFSTAND	OVERMETEN	HOOGTE	BREEDTE	BEVESTIGING	ARTIKEL NR.	SNELCODE
128mm	139mm	28mm	13mm	M4 vijs	0706GR72281427	01045



MATIC greep inox look

BOORAFSTAND	OVERMETEN	DIAMETER	BEVESTIGING	ARTIKEL NR.	SNELCODE
96mm	126mm	13mm	M4 vijs	0706V7032038	05047
128mm	160mm	14mm	M4 vijs	0706V7031038	06047

Ook verkrijgbaar in wit en zwart (zie pagina F 35)



SERENA greep inox look

BOORAFSTAND	OVERMETEN	BREEDTE	BEVESTIGING	ARTIKEL NR.	SNELCODE
128mm	154mm	17mm	M4 vijs	0706GR8510319	03045

A

MODERNE & KLASSIEKE GREPEN



SANTA CRUZ greep mat vernikkeld

BOORAFSTAND	OVERMETEN	BREEDTE	BEVESTIGING	ARTIKEL NR.	SNELCODE
128mm	186mm	23mm	M4 vijs	0706GR8562427	01046



SENEGAL greep inox look

BOORAFSTAND	OVERMETEN	BREEDTE	BEVESTIGING	ARTIKEL NR.	SNELCODE
128mm	152mm	20mm	M4 vijs	0706GR8744419	02046



U-TURN greep

UITVOERING	BOORAFSTAND	OVERMETEN	HOOGTE	DIAMETER	BEVESTIGING	ARTIKEL NR.	SNELBESTEL
Antiek grijs	160mm	187mm	38mm	7mm	M4 vijs	0706FP540160-22	10120
Brons antiek	160mm	187mm	38mm	7mm	M4 vijs	0706FP540160-23	11120
Inox look	160mm	187mm	38mm	7mm	M4 vijs	0706FP540160-66	12120
Mat zwart	160mm	187mm	38mm	7mm	M4 vijs	0706FP540160-99	13120

A

MODERNE & KLASSIEKE GREPEN



CYLINDER greep inox look

BOORAFSTAND	OVERMETEN	HOOGTE	DIAMETER	BEVESTIGING	ARTIKEL NR.	SNELCODE
160mm	176mm	34mm	16mm	M4 vijs	0706FP417220160	01026

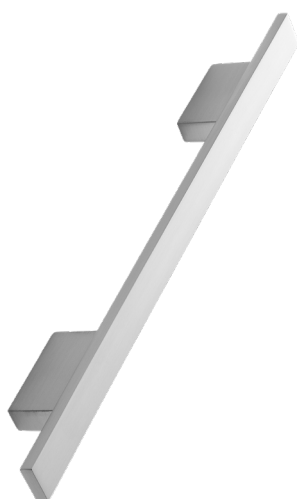

ELE greep inox look

BOORAFSTAND	OVERMETEN	HOOGTE	DIAMETER	BEVESTIGING	ARTIKEL NR.	SNELCODE
160/192mm	260mm	25mm	16mm	M4 vijs	0706FP516860160	03016



CYRUS knop zamak inox look

HOOGTE	DIAMETER	BEVESTIGING	ARTIKEL NR.	SNELCODE
23mm	28mm	M4 vijs	0706GR08522019	03041
27mm	34mm	M4 vijs	0706GR08522219	04041

CYRUS greep aluminium inox look

BOORAFSTAND	OVERMETEN	HOOGTE	DIAMETER	BEVESTIGING	ARTIKEL NR.	SNELCODE
96mm	126mm	27mm	17mm	M4 vijs	0706GR08511319	01041
128mm	159mm	27mm	17mm	M4 vijs	0706GR08511419	02041

A MODERNE & KLASSIEKE GREPEN



KEY inox look

BOORAFSTAND	OVERMETEN	HOOGTE	DIAMETER	BEVESTIGING	ARTIKEL NR.	SNELCODE
160mm	190mm	35mm	5/19mm	M4 vijz	0706FP526560160	01017



SAFARI lederen knop - inox look

UITVOERING	BOORAFSTAND	LENGTE	BREEDTE	HOOGTE	BEVESTIGING	ARTIKEL NR.	SNELCODE
Cognac	16mm	67mm	24mm	25mm	M4 vijzen	0706FP5381-105	53814



SLIM greep

UITVOERING	BOORAFSTAND	OVERMETEN	HOOGTE	BEVESTIGING	ARTIKEL NR.	SNELCODE
Inox look	160mm	200mm	30mm	M4 vijs	0706FP5154160IL	01009
Inox look	320mm	360mm	30mm	M4 vijs	0706FP5154320IL	02009
Inox look	448mm	488mm	30mm	M4 vijs	0706FP5154448IL	03009
Zwart	160mm	200mm	30mm	M4 vijs	0706ZW515460160	20123
Zwart	320mm	360mm	30mm	M4 vijs	0706ZW515460320	20223
Zwart	448mm	488mm	30mm	M4 vijs	0706ZW515460448	20225



PYRAMID greep

UITVOERING	BOORAFSTAND	OVERMETEN	HOOGTE	BEVESTIGING	ARTIKEL NR.	SNELCODE
Inox look	160mm	173mm	30mm	M4 vijs	0706FP5187160IL	03008
Inox look	320mm	333mm	30mm	M4 vijs	0706FP5187320IL	04008
Zwart	160mm	173mm	30mm	M4 vijs	0706ZW518760160	20221
Zwart	320mm	333mm	30mm	M4 vijs	0706ZW518760320	20121

A MODERNE & KLASSIEKE GREPEN



FRAME greep

UITVOERING	BOORAFSTAND	OVERMETEN	BREEDTE	DIAMETER	BEVESTIGING	ARTIKEL NR.	SNELCODE
Zwart	160mm	178mm	34mm	12mm	M4 vijs	0706FP517760ZW	11036



ANGÈLE greep inox

BOORAFSTAND	OVERMETEN	HOOGTE	DIAMETER	BEVESTIGING	ARTIKEL NR.	SNELCODE
96mm	109mm	30mm	13mm	M4 vijs	0706FP220133096	01010
128mm	141mm	30mm	13mm	M4 vijs	0706FP220133128	02010
160mm	173mm	30mm	13mm	M4 vijs	0706FP220133160	03010
192mm	205mm	30mm	13mm	M4 vijs	0706FP220133192	04010
224mm	237mm	30mm	13mm	M4 vijs	0706FP220133224	05010
288mm	301mm	30mm	13mm	M4 vijs	0706FP220133288	06010

Grepen voor hoge deuren

Maak kennis met ons nieuwe programma grepen, geschikt voor hoge deuren die je kan terug vinden op slaapkamerkasten maar ook bij hoge schuifdeuren, keukens en kantoor meubilair. Meestal vind je per collectie ook dezelfde greep in kleinere afmetingen of als knop uitvoering om de bijpassende lades en kleinere deuren met hetzelfde design uit te rusten. Niet alleen de vormgeving is brandend actueel, ook de gekozen kleuren en uitvoeringen komen tegemoet aan de vragen van de interieur designers: mat wit, mat zwart, maar ook messing kleur zodat je een antwoord kunt bieden op alle actuele vragen.



LINKK greep aluminium

UITVOERING	BOORAFSTAND	OVERMETEN	HOOGTE	BEVESTIGING	ARTIKEL NR.	SNELCODE
Inox look	160mm	175mm	37mm	M4	VIE0643160-IL	64301
Messing	160mm	175mm	37mm	M4	VIE0643160-MES	64302
Zwart	160mm	175mm	37mm	M4	VIE0643160-ZW	64303
Inox look	320mm	335mm	37mm	M4	VIE0643320-IL	64304
Messing	320mm	335mm	37mm	M4	VIE0643320-MES	64304
Zwart	320mm	335mm	37mm	M4	VIE0643320-ZW	64306
Inox look	528/ 1056mm	1071mm	37mm	M4	VIE06431056-IL	64307
Messing	528/ 1056mm	1071mm	37mm	M4	VIE06431056-MES	64308
Zwart	528/ 1056mm	1071mm	37mm	M4	VIE06431056-ZW	64309

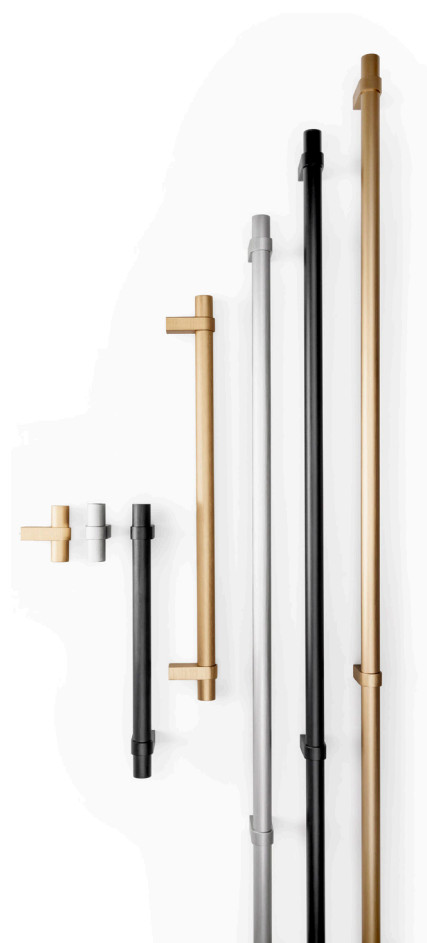

NOBB knop & greep aluminium

UITVOERING	BOORAFSTAND	OVERMETEN	HOOGTE	BEVESTIGING	ARTIKEL NR.	SNELCODE
Inox look	/	52mm	45mm	M4	VIE0657-0052-IL	65701
Zwart	/	52mm	45mm	M4	VIE0657-0052-ZW	65702
Messing	/	52mm	45mm	M4	VIE0657-0052-MES	65703
Inox look	192mm	244mm	45mm	M4	VIE0657-0192-IL	65704
Zwart	192mm	244mm	45mm	M4	VIE0657-0192-ZW	65705
Messing	192mm	244mm	45mm	M4	VIE0657-0192-MES	65706
Inox look	320mm	372mm	45mm	M4	VIE0657-0320-IL	65707
Zwart	320mm	372mm	45mm	M4	VIE0657-0320-ZW	65708
Messing	320mm	372mm	45mm	M4	VIE0657-0320-MES	65709
Inox look	528/1056mm	1108mm	45mm	M4	VIE0657-1056-IL	65710
Zwart	528/1056mm	1108mm	45mm	M4	VIE0657-1056-ZW	65711
Messing	528/1056mm	1108mm	45mm	M4	VIE0657-1056-MES	65712



EDGE STRAIGHT greep

UITVOERING	BOORAFSTAND	OVERMETEN	HOOGTE	BREEDTE	BEVESTIGING	ARTIKEL NR.	SNELCODE
Messing kleur	160mm	600mm	18mm	41mm	M4	0706FP41972600M	32601
Inox look	160mm	600mm	18mm	41mm	M4	0706FP41972600I	32602
Zwart mat	160mm	600mm	18mm	41mm	M4	0706FP41972600Z	32603
Messing kleur	160mm	1200mm	18mm	41mm	M4	0706FP41972912M	32101
Inox look	160mm	1200mm	18mm	41mm	M4	0706FP41972912I	32102
Zwart mat	160mm	1200mm	18mm	41mm	M4	0706FP41972912Z	32103

Ontdek andere knoppen en grepen uit deze reeks in hoofdstuk C op pagina C 7

Technische Fiche



WING greep aluminium

UITVOERING	BOORAFSTAND	OVERMETEN	HOOGTE	BREEDTE	BEVESTIGING	ARTIKEL NR.	SNELCODE
Inox look	64mm	100mm	18mm	42mm	M4	VIE0600-0100-IL	60001
Zwart	64mm	100mm	18mm	42mm	M4	VIE0600-0100-ZW	60002
Brons antiek	64mm	100mm	18mm	42mm	M4	VIE0600-0100-BA	60003
Messing	64mm	100mm	18mm	42mm	M4	VIE0600-0100-MES	60004
Inox look	128mm	200mm	18mm	42mm	M4	VIE0600-0200-IL	60005
Zwart	128mm	200mm	18mm	42mm	M4	VIE0600-0200-ZW	60006
Brons antiek	128mm	200mm	18mm	42mm	M4	VIE0600-0200-BA	60007
Messing	128mm	200mm	18mm	42mm	M4	VIE0600-0200-MES	60008
Inox look	256mm	350mm	18mm	42mm	M4	VIE0600-0350-IL	60009
Zwart	256mm	350mm	18mm	42mm	M4	VIE0600-0350-ZW	60010
Brons antiek	256mm	350mm	18mm	42mm	M4	VIE0600-0350-BA	60011
Messing	256mm	350mm	18mm	42mm	M4	VIE0600-0350-MES	60012
Inox look	384/1120mm	1200mm	18mm	42mm	M4	VIE0600-1200-IL	60013
Zwart	384/1120mm	1200mm	18mm	42mm	M4	VIE0600-1200-ZW	60014
Brons antiek	384/1120mm	1200mm	18mm	42mm	M4	VIE0600-1200-BA	60015
Messing	384/1120mm	1200mm	18mm	42mm	M4	VIE0600-1200-MES	60016

Technische Fiche



FLAPP greep aluminium

UITVOERING	BOORAFSTAND	OVERMETEN	HOOGTE	BEVESTIGING	ARTIKEL NR.	SNELCODE
Inox look	32mm	70mm	22mm	M4	VIE0610-070-IL	61004
Zwart mat	32mm	70mm	22mm	M4	VIE0610-070-ZM	61005
Messing	32mm	70mm	22mm	M4	VIE0610-070-MES	61006
Inox look	128 / 160mm	200mm	22mm	M4	VIE0610-160-IL	61002
Zwart mat	128 / 160mm	200mm	22mm	M4	VIE0610-160-ZM	61001
Messing	128 / 160mm	200mm	22mm	M4	VIE0610-160-MES	61003
Inox look	256mm	350mm	22mm	M4	VIE0610-350-IL	61007
Zwart mat	256mm	350mm	22mm	M4	VIE0610-350-ZM	61008
Messing	256mm	350mm	22mm	M4	VIE0610-350-MES	61009
Inox look	416 / 1056mm	1100mm	22mm	M4	VIE0610-1100-IL	61010
Zwart mat	416 / 1056mm	1100mm	22mm	M4	VIE0610-1100-ZM	61011
Messing	416 / 1056mm	1100mm	22mm	M4	VIE0610-1100-MES	61012

Technische Fiche



FLAPP WOOD greep hout

UITVOERING	BOORAFSTAND	OVERMETEN	HOOGTE	BEVESTIGING	ARTIKEL NR.	SNELCODE
Eik brut	32mm	70mm	22mm	M4	VIE0613-070-EIKB	61301
Eik vernis	32mm	70mm	22mm	M4	VIE0613-070-EIKV	61302
Walnoot	32mm	70mm	22mm	M4	VIE0613-070-NOOT	61303
Eik brut	160mm	200mm	22mm	M4	VIE0613-200-EIKB	61304
Eik vernis	160mm	200mm	22mm	M4	VIE0613-200-EIKV	61305
Walnoot	160mm	200mm	22mm	M4	VIE0613-200-NOOT	61306
Eik brut	416/1056mm	1100mm	22mm	M4	VIE0613-1100-EIKB	61307
Eik vernis	416/1056mm	1100mm	22mm	M4	VIE0613-1100-EIKV	61308
Walnoot	416/1056mm	1100mm	22mm	M4	VIE0613-1100-NOOT	61309

B GREPEN VOOR HOGE DEUREN

Technische Fiche



PEAK greep

KLEUR	UITVOERING	BOORAFSTAND	OVERMETEN	ARTIKEL NR.	SNELCODE
Mat wit	greep midden	160/192 mm	250mm	VIE444-250-WIT	44401
Mat wit	greep midden	160/448 mm	500mm	VIE444-500-WIT	44402
Mat wit	greep midden	160/768 mm	800mm	VIE444-800-WIT	44403
Mat wit	greep boven	160/1120 mm	1150mm	VIE444-1150-WIT	44404
Mat wit	greep midden	160/1760 mm	1800mm	VIE444-1800-WIT	44405
Zwart	greep midden	160/192 mm	250mm	VIE444-250-ZW	44406
Zwart	greep midden	160/448 mm	500mm	VIE444-500-ZW	44407
Zwart	greep midden	160/768 mm	800mm	VIE444-800-ZW	44408
Zwart	greep boven	160/1120 mm	1150mm	VIE444-1150-ZW	44409
Zwart	greep midden	160/1760 mm	1800mm	VIE444-1800-ZW	44410

Technische Fiche

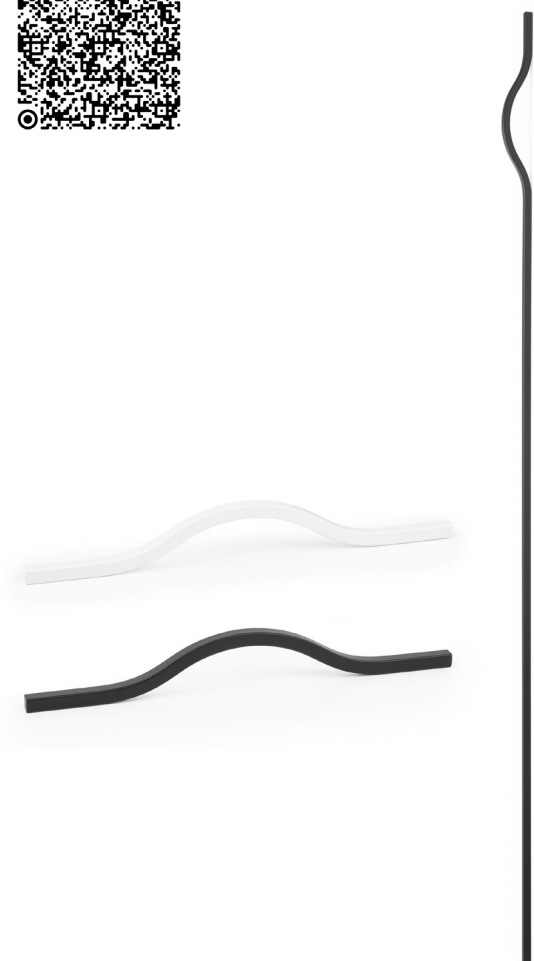

B

BRAVE greep

KLEUR	UITVOERING	BOORAFSTAND	OVERMETEN	ARTIKEL NR.	SNELCODE
Mat wit	greep midden	128mm	160mm	VIE452-160-WIT	45201
Mat wit	greep midden	192mm	240mm	VIE452-240-WIT	45202
Mat wit	greep midden	320mm	400mm	VIE452-400-WIT	45203
Mat wit	greep midden	192/480 mm	600mm	VIE452-600-WIT	45204
Mat wit	greep bovenaan	192/992 mm	1040mm	VIE452-1040-WIT	45205
Mat wit	greep midden	192/1120 mm	1150mm	VIE452-1150-WIT	45206
Mat zwart	greep midden	128mm	160mm	VIE452-160-ZW	45207
Mat zwart	greep midden	192mm	240mm	VIE452-240-ZW	45208
Mat zwart	greep midden	320mm	400mm	VIE452-400-ZW	45209
Mat zwart	greep midden	192/480 mm	600mm	VIE452-600-ZW	45210
Mat zwart	greep bovenaan	192/992 mm	1040mm	VIE452-1040-ZW	45211
Mat zwart	greep midden	192/1120 mm	1150mm	VIE452-1150-ZW	45212

B GREPEN VOOR HOGE DEUREN

Technische Fiche



VANN greep

UITVOERING	BOORAFSTAND	OVEREMTEN	BEVESTIGING	ARTIKEL NR.	SNELCODE
Messing kleur	64mm	100mm	M4	VIE0375-100-MS	37501
Messing kleur	128mm	200mm	M4	VIE0375-200-MS	37502
Messing kleur	256mm	350mm	M4	VIE0375-350-MS	37503
Messing kleur	384/1120mm	1200mm	M4	VIE0375-1200-MS	37504
Mat zwart	64mm	100mm	M4	VIE0375-100-ZW	37505
Mat zwart	128mm	200mm	M4	VIE0375-200-ZW	37506
Mat zwart	256mm	350mm	M4	VIE0375-350-ZW	37507
Mat zwart	384/1120mm	1200mm	M4	VIE0375-1200-ZW	37508

Technische Fiche



B

ONA greep

UITVOERING	BOORAFSTAND	OVERMETEN	BEVESTIGING	ARTIKEL NR.	SNELCODE
Mat wit	32mm	50mm	M4	VIE0372-50-WI	37201
Mat wit	128mm	200mm	M4	VIE0372-200-WI	37202
Mat wit	256mm	350mm	M4	VIE0372-350-WI	37203
Mat wit	544mm	600mm	M4	VIE0372-600-WI	37204
Mat wit	416/1056 mm	1100mm	M4	VIE0372-1100-WI	37205
Mat wit	480/1440 mm	1500mm	M4	VIE0372-1500-WI	37206
Geborsteld zwart	32mm	50mm	M4	VIE0372-50-ZW	37207
Geborsteld zwart	128mm	200mm	M4	VIE0372-200-ZW	37208
Geborsteld zwart	256mm	350mm	M4	VIE0372-350-ZW	37209
Geborsteld zwart	544mm	600mm	M4	VIE0372-600-ZW	37210
Geborsteld zwart	416/1056 mm	1100mm	M4	VIE0372-1100-ZW	37211
Geborsteld zwart	480/1440 mm	1500mm	M4	VIE0372-1500-ZW	37212

Technische Fiche

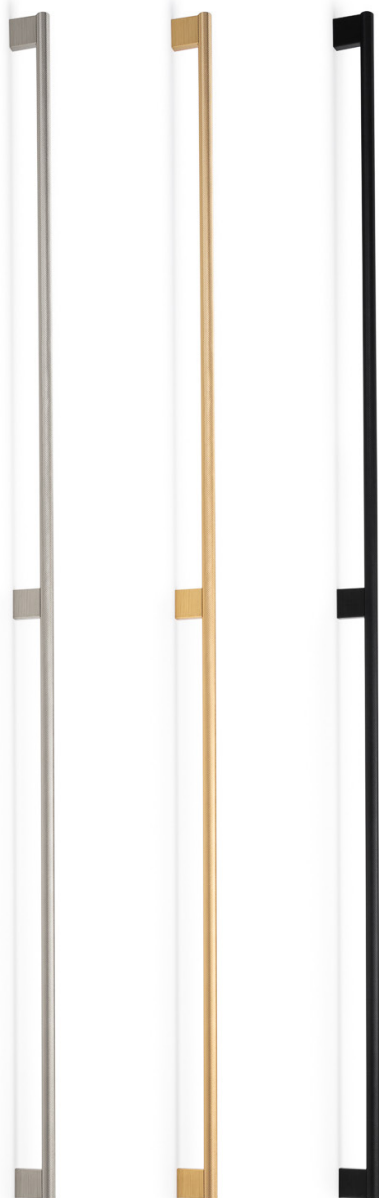

GRAF MINI greep met 3 steunen

UITVOERING	BOORAFSTAND	OVERMETEN	HOOGTE	BEVESTIGING	ARTIKEL NR.	SNELCODE
Zwart	589 / 1178mm	1200mm	33mm	M4	VIE430-1200-ZW	43013
Messing	589 / 1178mm	1200mm	33mm	M4	VIE430-1200-MS	43008
Inox look	589 / 1178mm	1200mm	33mm	M4	VIE430-1200-IXL	43003

Ontdek andere knoppen en grepen uit deze reeks op pagina A 17

Technische Fiche



B

KOMPI greep

UITVOERING	BOORAFSTAND	OVERMETEN	HOOGTE	BEVESTIGING	ARTIKEL NR.	SNELCODE
Inox	160mm	182mm	45mm	M4	VIE0064-182-IX	64001
Inox	192mm	214mm	45mm	M4	VIE0064-214-IX	64002
Inox	292mm	314mm	45mm	M4	VIE0064-314-IX	64003
Inox	342mm	364mm	45mm	M4	VIE0064-364-IX	64004
Inox	392mm	414mm	45mm	M4	VIE0064-414-IX	64005
Inox	492mm	514mm	45mm	M4	VIE0064-514-IX	64006
Inox	792mm	814mm	45mm	M4	VIE0064-814-IX	64007
Inox	546/1092mm	1114mm	45mm	M4	VIE0064-1114-IX	64008

B GREPEN VOOR HOGE DEUREN



Technische Fiche

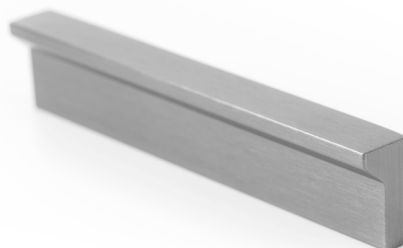

ANGLE greep

UITVOERING	BOORAFSTAND	OVERMETEN	HOOGTE	BEVESTIGING	ARTIKEL NR.	SNELCODE
Inox look	64mm	100mm	11mm	M4	VIE0077-100-IXL	77001
Inox look	128mm	200mm	11mm	M4	VIE0077-200-IXL	77002
Inox look	192mm	300mm	11mm	M4	VIE0077-300-IXL	77003
Inox look	256mm	400mm	11mm	M4	VIE0077-400-IXL	77004
Inox look	416mm	500mm	11mm	M4	VIE0077-500-IXL	77005
Inox look	480mm	600mm	11mm	M4	VIE0077-600-IXL	77006
Inox look	640mm	900mm	11mm	M4	VIE0077-900-IXL	77007
Mat wit	64mm	100mm	11mm	M4	VIE0077-100-WIT	77008
Mat wit	128mm	200mm	11mm	M4	VIE0077-200-WIT	77009
Mat wit	192mm	300mm	11mm	M4	VIE0077-300-WIT	77010
Mat wit	256mm	400mm	11mm	M4	VIE0077-400-WIT	77011
Mat wit	416mm	500mm	11mm	M4	VIE0077-500-WIT	77012
Mat wit	480mm	600mm	11mm	M4	VIE0077-600-WIT	77013
Mat wit	640mm	900mm	11mm	M4	VIE0077-900-WIT	77014
Mat wit	1440mm	1480mm	11mm	M4	VIE0077-1440-WIT	77023
Mat zwart	64mm	100mm	11mm	M4	VIE0077-100-ZW	77015
Mat zwart	128mm	200mm	11mm	M4	VIE0077-200-ZW	77016
Mat zwart	192mm	300mm	11mm	M4	VIE0077-300-ZW	77017
Mat zwart	256mm	400mm	11mm	M4	VIE0077-400-ZW	77018
Mat zwart	416mm	500mm	11mm	M4	VIE0077-500-ZW	77019
Mat zwart	480mm	600mm	11mm	M4	VIE0077-600-ZW	77020
Mat zwart	640mm	900mm	11mm	M4	VIE0077-900-ZW	77021
Mat zwart	1440mm	1480mm	11mm	M4	VIE0077-1440-ZW	77022

Infrees & opzetgrepen

Infreesgrepen vind je in verschillende vormen, uitvoeringen en afmetingen terug maar allemaal hebben ze hetzelfde doel: opgaan in het meubel. Zo combineren ze functionaliteit en design, zitten ze niet in de weg bij schuifdeuren maar worden ze ook gebruikt om ladefronten en deuren te openen. Zowel beschikbaar in afgeronde vormen als strakke rechte modellen voor iedere smaak en design in hedendaagse uitvoeringen.

Technische Fiche



CUBIC infreesgreep

UITVOERING	FREESMAAT LENGTE	OVERMETEN	BOORMATEN	OVERMETEN BREEDTE	ARTIKEL NR.	SNELCODE
Mat wit	157mm	160mm	scan QR-code	24mm	VIE0366-160-WI	36601
Mat zwart	157mm	160mm	scan QR-code	24mm	VIE0366-160-ZW	36602

Technische Fiche



WING opzetgreep aluminium

UITVOERING	BOORAFSTAND	OVERMETEN	HOOGTE	BREEDTE	BEVESTIGING	ARTIKEL NR.	SNELCODE
Inox look	64mm	100mm	18mm	42mm	M4	VIE0600-0100-IL	60001
Zwart	64mm	100mm	18mm	42mm	M4	VIE0600-0100-ZW	60002
Brons antiek	64mm	100mm	18mm	42mm	M4	VIE0600-0100-BA	60003
Messing	64mm	100mm	18mm	42mm	M4	VIE0600-0100-MES	60004
Inox look	128mm	200mm	18mm	42mm	M4	VIE0600-0200-IL	60005
Zwart	128mm	200mm	18mm	42mm	M4	VIE0600-0200-ZW	60006
Brons antiek	128mm	200mm	18mm	42mm	M4	VIE0600-0200-BA	60007
Messing	128mm	200mm	18mm	42mm	M4	VIE0600-0200-MES	60008
Inox look	256mm	350mm	18mm	42mm	M4	VIE0600-0350-IL	60009
Zwart	256mm	350mm	18mm	42mm	M4	VIE0600-0350-ZW	60010
Brons antiek	256mm	350mm	18mm	42mm	M4	VIE0600-0350-BA	60011
Messing	256mm	350mm	18mm	42mm	M4	VIE0600-0350-MES	60012
Inox look	384/1120mm	1200mm	18mm	42mm	M4	VIE0600-1200-IL	60013
Zwart	384/1120mm	1200mm	18mm	42mm	M4	VIE0600-1200-ZW	60014
Brons antiek	384/1120mm	1200mm	18mm	42mm	M4	VIE0600-1200-BA	60015
Messing	384/1120mm	1200mm	18mm	42mm	M4	VIE0600-1200-MES	60016

C INFREES EN OPZETGREPEN

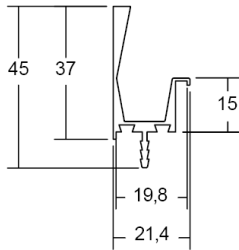

Doorsnede profiel



Afdekplaat links

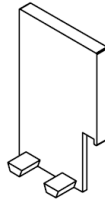

Afdekplaat rechts



Lengte 3m –
zelf op maat te
verzagen

Technische Fiche



HEXXA infreesgreep

UITVOERING	LENGTE	EINKAPPEN	AFMETINGEN	BEVESTIGING	ARTIKEL NR.	SNELCODE
Metaal bruin	200mm	inbegrepen	zie tekening	infrezen	VIE0449-0200-B	44904
Metaal grijs	200mm	inbegrepen	zie tekening	infrezen	VIE0449-0200-G	44903
Mat wit	200mm	inbegrepen	zie tekening	infrezen	VIE0449-0200-W	44901
Mat zwart	200mm	inbegrepen	zie tekening	infrezen	VIE0449-0200-Z	44902
Metaal bruin	350mm	inbegrepen	zie tekening	infrezen	VIE0449-0350-B	44907
Metaal grijs	350mm	inbegrepen	zie tekening	infrezen	VIE0449-0350-G	44908
Mat wit	350mm	inbegrepen	zie tekening	infrezen	VIE0449-0350-W	44905
Mat zwart	350mm	inbegrepen	zie tekening	infrezen	VIE0449-0350-Z	44906
Metaal bruin	1100mm	inbegrepen	zie tekening	infrezen	VIE0449-1100-B	44911
Metaal grijs	1100mm	inbegrepen	zie tekening	infrezen	VIE0449-1100-G	44912
Mat wit	1100mm	inbegrepen	zie tekening	infrezen	VIE0449-1100-W	44909
Mat zwart	1100mm	inbegrepen	zie tekening	infrezen	VIE0449-1100-Z	44910
Metaal bruin	3000mm	zonder eindkap	zie tekening	infrezen	VIE0449-3000-B	44915
Metaal grijs	3000mm	zonder eindkap	zie tekening	infrezen	VIE0449-3000-G	44916
Mat wit	3000mm	zonder eindkap	zie tekening	infrezen	VIE0449-3000-W	44913
Mat zwart	3000mm	zonder eindkap	zie tekening	infrezen	VIE0449-3000-Z	44914



Nieuw! Lengte inkortbaar.

HEXXA eindkap

Metaal bruin	eindkap links	voor afmetingen zie tekening	VIE0449-035-BL	44921
Metaal bruin	eindkap rechts	voor afmetingen zie tekening	VIE0449-035-BR	44922
Metaal grijs	eindkap links	voor afmetingen zie tekening	VIE0449-035-GL	44923
Metaal grijs	eindkap rechts	voor afmetingen zie tekening	VIE0449-035-GR	44924
Mat wit	eindkap links	voor afmetingen zie tekening	VIE0449-035-WL	44917
Mat wit	eindkap rechts	voor afmetingen zie tekening	VIE0449-035-WR	44918
Mat zwart	eindkap links	voor afmetingen zie tekening	VIE0449-035-ZL	44919
Mat zwart	eindkap rechts	voor afmetingen zie tekening	VIE0449-035-ZR	44920



Technische Fiche



EDGE STRAIGHT greep

UITVOERING	BOORAFSTAND	OVERMETEN	BOORGATEN	BREEDTE	BEVESTIGING	ARTIKEL NR.	SNELCODE
Inox look	20mm	40mm	2	41mm	M4	0706FP41972-40I	01062
Inox look	60mm	100mm	2	41mm	M4	0706FP41972100I	41970
Inox look	80mm	200mm	3	41mm	M4	0706FP41972-20I	02062
Inox look	160mm	350mm	3	41mm	M4	0706FP41972-35I	03062
Inox look	160mm	600mm	4	41mm	M4	0706FP41972600I	32602
Inox look	160mm	1200mm	7	41mm	M4	0706FP41972912I	32102

NIEUW!

UITVOERING	BOORAFSTAND	OVERMETEN	BOORGATEN	BREEDTE	BEVESTIGING	ARTIKEL NR.	SNELCODE
Messing kleur	20mm	40mm	2	41mm	M4	0706FP41972-40M	11062
Messing kleur	60mm	100mm	2	41mm	M4	0706FP41972100M	41976
Messing kleur	80mm	200mm	3	41mm	M4	0706FP41972200M	18062
Messing kleur	160mm	350mm	3	41mm	M4	0706FP41972350M	25062
Messing kleur	160mm	600mm	4	41mm	M4	0706FP41972600M	32601
Messing kleur	160mm	1200mm	7	41mm	M4	0706FP41972912M	32101

NIEUW!

UITVOERING	BOORAFSTAND	OVERMETEN	BOORGATEN	BREEDTE	BEVESTIGING	ARTIKEL NR.	SNELCODE
Zwart mat	20mm	40mm	2	41mm	M4	0706FP41972-40Z	30062
Zwart mat	60mm	100mm	2	41mm	M4	0706FP41972100Z	41972
Zwart mat	80mm	200mm	3	41mm	M4	0706FP41972200Z	31062
Zwart mat	160mm	350mm	3	41mm	M4	0706FP41972350Z	32062
Zwart mat	160mm	600mm	4	41mm	M4	0706FP41972600Z	32603
Zwart mat	160mm	1200mm	7	41mm	M4	0706FP41972912Z	32103

NIEUW!

UITVOERING	BOORAFSTAND	OVERMETEN	BOORGATEN	BREEDTE	BEVESTIGING	ARTIKEL NR.	SNELCODE
Rose gold	20mm	40mm	2	41mm	M4	0706FP41972-40R	12062
Rose gold	80mm	200mm	3	41mm	M4	0706FP41972200R	19062
Rose gold	160mm	350mm	3	41mm	M4	0706FP41972350R	26062

UITVOERING	BOORAFSTAND	OVERMETEN	BOORGATEN	BREEDTE	BEVESTIGING	ARTIKEL NR.	SNELCODE
Wit	20mm	40mm	2	41mm	M4	0706FP41972-40W	13062
Wit	60mm	100mm	2	41mm	M4	0706FP41972100W	41973
Wit	80mm	200mm	3	41mm	M4	0706FP41972200W	20062
Wit	160mm	350mm	3	41mm	M4	0706FP41972350W	27062

C INFREES EN OPZETGREPEN



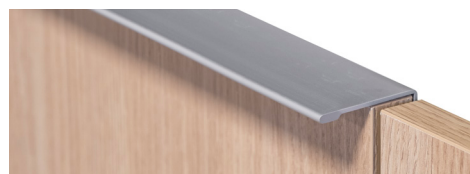

L-GREEP aluminium

UITVOERING	OVERMETEN	DIKTE	AANTAL BORINGEN	BEVESTIGING	ARTIKEL NR.	SNELCODE
ALU geanod.	40mm	1.5mm	2	Houtvijs	SGK.35154	03064
ALU geanod.	70mm	1.5mm	2	Houtvijs	SGK.35155	04064
ALU geanod.	150mm	1.5mm	3	Houtvijs	SGK.35156	05064
ALU geanod.	300mm	1.5mm	3	Houtvijs	SGK.35157	06064
ALU geanod.	500mm	1.5mm	3	Houtvijs	SGK.35158	07064
ALU geanod.	1000mm	1.5mm	4	Houtvijs	SGK.35200	35200
ALU geanod.	3000mm	1.5mm	Geen boringen	Houtvijs	SGK.35155.3M	08064
ALU brut	3000mm	1.5mm	Geen boringen	Houtvijs	SGK.35155.3MBR	09064
Messing/gold	3000mm	1.5mm	Geen boringen	Houtvijs	SGK.35155.3MME	09090
Zwart geanod.	3000mm	1.5mm	Geen boringen	Houtvijs	SGK.35155.3MZW	09086

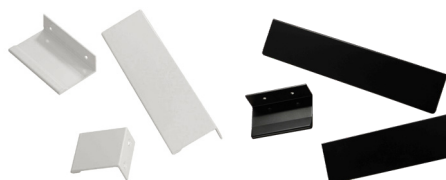

L-GREEP gelakt

UITVOERING	OVERMETEN	DIKTE	AANTAL BORINGEN	BEVESTIGING	ARTIKEL NR.	SNELCODE
Wit gelakt mat	40mm	1.5mm	2	Houtvijs	SGK.35159	10064
Wit gelakt mat	70mm	1.5mm	2	Houtvijs	SGK.35160	11064
Wit gelakt mat	150mm	1.5mm	3	Houtvijs	SGK.35161	12064
Wit gelakt mat	300mm	1.5mm	3	Houtvijs	SGK.35162	13064
Wit gelakt mat	500mm	1.5mm	3	Houtvijs	SGK.35163	14064
Wit gelakt mat	1000mm	1.5mm	4	Houtvijs	SGK.35201	35201
Zwart gelakt mat	40mm	1.5mm	2	Houtvijs	SGK.35164	15064
Zwart gelakt mat	70mm	1.5mm	2	Houtvijs	SGK.35165	16064
Zwart gelakt mat	150mm	1.5mm	3	Houtvijs	SGK.35166	17064
Zwart gelakt mat	300mm	1.5mm	3	Houtvijs	SGK.35167	18064
Zwart gelakt mat	500mm	1.5mm	3	Houtvijs	SGK.35168	19064
Zwart gelakt mat	1000mm	1.5mm	4	Houtvijs	SGK.35202	35202

Zwarte houtvijzen 3.0x16 - zie pagina N 2

Technische Fiche

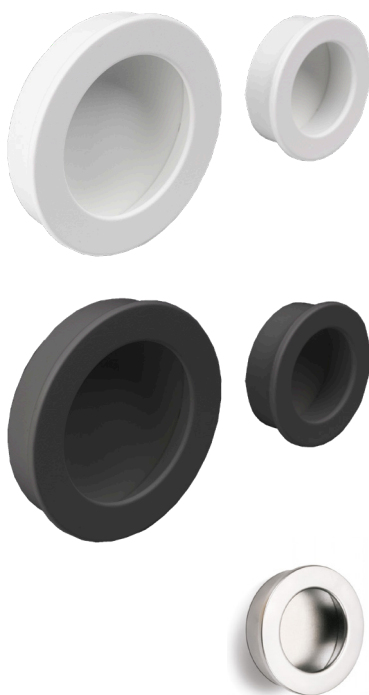

ROND infreesgreep

UITVOERING	OVERMETEN	DIEPTE	BEVESTIGING	ARTIKEL NR.	SNELCODE
Zwart	65mm	11mm	Infrezen	0706V3500.032	20106
Zwart	40mm	11mm	Infrezen	0706V3511.032	20206
Zwart	30mm	11mm	Infrezen	0706V3512.032	20306
Wit	65mm	11mm	Infrezen	0706V3500.292	20406
Wit	40mm	11mm	Infrezen	0706V3511.292	20506
Wit	30mm	11mm	Infrezen	0706V3512.292	20606
Inox look	30mm	11mm	Infrezen	0706V3511 038	53511

Technische Fiche



VIERKANT infreesgreep

UITVOERING	OVERMETEN	DIEPTE	BEVESTIGING	ARTIKEL NR.	SNELCODE
Zwart	64x64mm	11mm	Infrezen	0706V3600.032	20107
Zwart	50x50mm	11mm	Infrezen	0706V3560.032	20207
Zwart	39x39mm	11mm	Infrezen	0706V3561.032	20307
Zwart	29x29mm	11mm	Infrezen	0706V3562.032	20407
Wit	64x64mm	11mm	Infrezen	0706V3600.292	20507
Wit	50x50mm	11mm	Infrezen	0706V3560.292	20607
Wit	39x39mm	11mm	Infrezen	0706V3561.292	20707
Wit	29x29mm	11mm	Infrezen	0706V3562.292	20807

Technische Fiche



INN infreesgriep

UITVOERING	OVERMETEN	BEVESTIGING	ARTIKEL NR.	SNELCODE
Inox look	50x50mm	Infrezen	0706FP512160050	04054
Inox look	70x120mm	Infrezen	0706FP512160120	05054
Inox look	50x160mm	Infrezen	0706FP512160160	06054

Technische Fiche



INN infreesgriep

UITVOERING	OVERMETEN	BEVESTIGING	ARTIKEL NR.	SNELCODE
Zwart	50x160mm	infrezen	0706ZW512160160	07054
Zwart	50x202mm	infrezen	0706ZW512160192	07059

NIEUW!

Technische Fiche

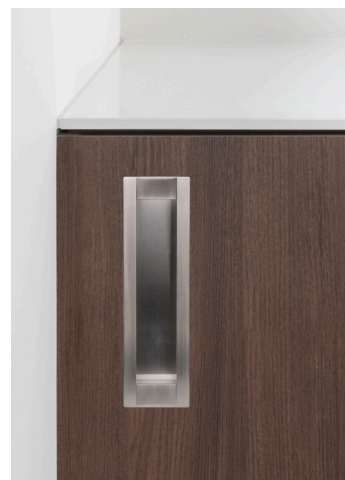

RECHTHOEK infreesgreep

UITVOERING	BOORAFSTAND	OVERMETEN	DIEPTE	BEVESTIGING	ARTIKEL NR.	SNELCODE
Zwart	160mm	180x50mm	14mm	Infrezen	0706V3720.032	20109
Wit	160mm	180x50mm	14mm	Infrezen	0706V3720.292	20209
Inox look	160mm	180x50mm	14mm	Infrezen	0706V3720.038	20309

Technische Fiche



SCHUIFDEUR infreesgreep

UITVOERING	OVERMETEN	BEVESTIGING	ARTIKEL NR.	SNELCODE
Inox look	150x40mm	Infrezen	0706V3921 038	53921
Inox look	110x36mm	Infrezen	0706V3922 038	53922
Zwart	150x40mm	Infrezen	0706V3921.032	20108
Zwart	110x36mm	Infrezen	0706V3922.032	20208
Wit	150x40mm	Infrezen	0706V3921.292	20308
Wit	110x36mm	Infrezen	0706V3922.292	20408

Technische Fiche



FLUSH infreesgriep inox look

BOORAFSTAND	OVERMETEN	BEVESTIGING	ARTIKEL NR.	SNELCODE
32mm	70x58mm	Infrezen	0706FP513660032	01053

Technische Fiche



ROUND infreesgriep inox

OVERMETEN	BEVESTIGING	ARTIKEL NR.	SNELCODE
50mm	Infrezen	0706FP220230050	01054
65mm	Infrezen	0706FP220230065	02054

Technische Fiche



LUX infreesgreep inox look

BOORAFSTAND	OVERMETEN	BREEDTE	BEVESTIGING	ARTIKEL NR.	SNELCODE
128mm	144mm	46mm	M4 vijzen	0706FP532-128IL	53212
192mm	208mm	46mm	M4 vijzen	0706FP532-192IL	53219

Technische Fiche

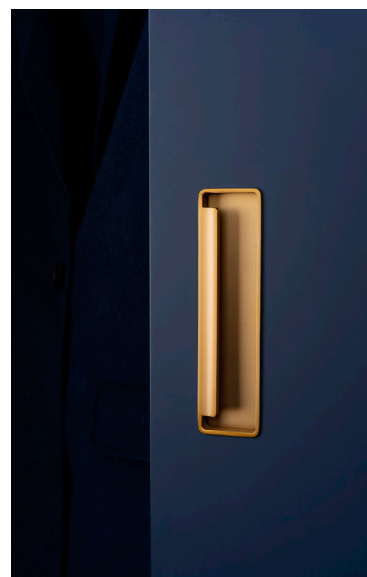
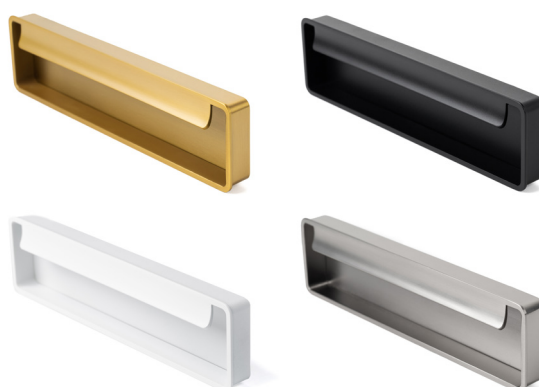

FOLD infreesgreep*

UITVOERING	BOORAFSTAND	OVERMETEN	BEVESTIGING	ARTIKEL NR.	SNELCODE
Goud	128mm	174x46mm	Infrezen	VIE0542-128-GO	54201
Inox look	128mm	174x46mm	Infrezen	VIE0542-128-IL	54202
Wit	128mm	174x46mm	Infrezen	VIE0542-128-WI	54203
Zwart	128mm	174x46mm	Infrezen	VIE0542-128-ZW	54204

*Ideale greep voor Concepta- of plooschuifdeuren!

Technische Fiche

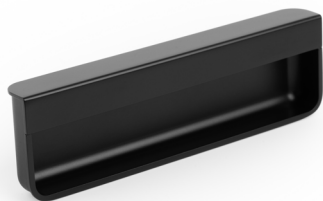
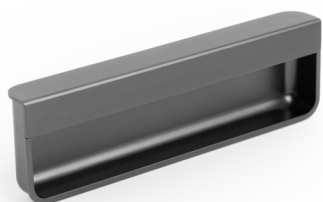

MOULE infreesgreep zamak

UITVOERING	BOORAFSTAND	OVERMETEN	FREESMAAT	HOOGTE	BEVESTIGING	ARTIKEL NR.	SNELCODE
Titanium zwart	128mm	154mm	zie QR code	45mm	infrezen	VIE0650128-MN	65001
Messing	128mm	154mm	zie QR code	45mm	infrezen	VIE0650128-MES	65002
Mat wit	128mm	154mm	zie QR code	45mm	infrezen	VIE0650128-MW	65003
Mat zwart	128mm	154mm	zie QR code	45mm	infrezen	VIE0650128-MZ	65004

Technische Fiche



HIDE infreesgreep zamak

UITVOERING	BOORAFSTAND	OVERMETEN	BEVESTIGING	ARTIKEL NR.	SNELCODE
Mat wit	128mm	180mm	Infrezen	VIE0094-180-WI	09401
Mat zwart	128mm	180mm	Infrezen	VIE0094-180-ZW	09402
Geborsteld goud	128mm	180mm	Infrezen	VIE0094-180-GO	09403

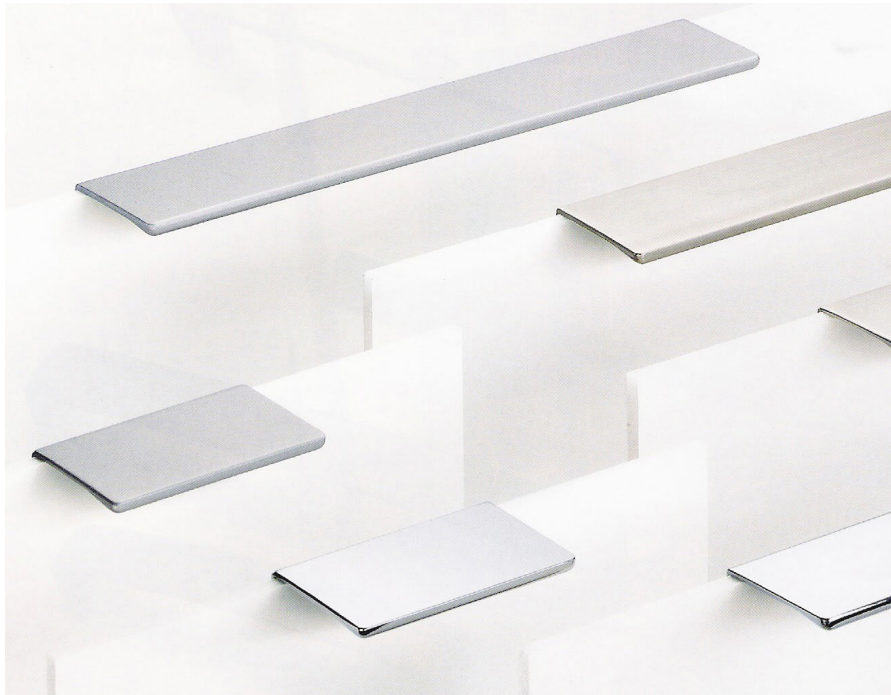

L-GREEP zamak

UITVOERING	BOORAFSTAND	OVERMETEN	BREEDTE	BEVESTIGING	ARTIKEL NR.	SNELCODE
Aluminium	32mm	71mm	45mm	Houtvijs	0706V7663 021	01063
Aluminium	96mm	135mm	45mm	Houtvijs	0706V7662 021	04063
Aluminium	192mm	231mm	45mm	Houtvijs	0706V7661 021	07063
Inox look	32mm	71mm	45mm	Houtvijs	0706V7663 038	02063
Inox look	96mm	135mm	45mm	Houtvijs	0706V7662 038	05063
Inox look	192mm	231mm	45mm	Houtvijs	0706V7661 038	08063
Chromé glans	32mm	71mm	45mm	Houtvijs	0706V7663 400	03063
Chromé glans	96mm	135mm	45mm	Houtvijs	0706V7662 400	06063
Chromé glans	192mm	231mm	45mm	Houtvijs	0706V7661 400	09063
Zwart	32mm	71mm	45mm	Houtvijs	0706V7663.032	20117
Zwart	96mm	135mm	45mm	Houtvijs	0706V7662.032	20217
Zwart	192mm	231mm	45mm	Houtvijs	0706V7661.032	20317
Wit	32mm	71mm	45mm	Houtvijs	0706V7663.292	20417
Wit	96mm	135mm	45mm	Houtvijs	0706V7662.292	20517
Wit	192mm	231mm	45mm	Houtvijs	0706V7661.292	20617



C

MALIBU curve opzetgreep inox look

LENGTE	FRONTMAAT	BREEDTE	HOOGTE	BEVESTIGING	ARTIKEL NR.	SNELCODE
295mm	300mm	45mm	12mm	Infrezen	0706FP416420295	01061
345mm	350mm	45mm	12mm	Infrezen	0706FP416420345	02061
395mm	400mm	45mm	12mm	Infrezen	0706FP416420395	03061
445mm	450mm	45mm	12mm	Infrezen	0706FP416420445	04061
495mm	500mm	45mm	12mm	Infrezen	0706FP416420495	05061
595mm	600mm	45mm	12mm	Infrezen	0706FP416420595	06061
795mm	800mm	45mm	12mm	Infrezen	0706FP416420795	07061
895mm	900mm	45mm	12mm	Infrezen	0706FP416420895	08061
995mm	1000mm	45mm	12mm	Infrezen	0706FP416420995	09061
1195mm	1200mm	45mm	12mm	Infrezen	0706FP416421195	10061

Technische Fiche



WAY opzetgreep

UITVOERING	BOORAFSTAND	OVERMETEN	ARTIKEL NR.	SNELCODE
ALU mat	32mm	50mm	VIE0518-0050-A	51801
ALU mat	64mm	100mm	VIE0518-0100-A	51806
ALU mat	128mm	200mm	VIE0518-0200-A	51811
ALU mat	320mm	400mm	VIE0518-0400-A	51816
ALU mat	368/736mm	800mm	VIE0518-0800-A	51821
ALU mat	352/1056mm	1100mm	VIE0518-1100-A	51826
Brons	32mm	50mm	VIE0518-0050-B	51802
Brons	64mm	100mm	VIE0518-0100-B	51807
Brons	128mm	200mm	VIE0518-0200-B	51812
Brons	320mm	400mm	VIE0518-0400-B	51817
Brons	368/736mm	800mm	VIE0518-0800-B	51822
Brons	352/1056mm	1100mm	VIE0518-1100-B	51827
Inox	32mm	50mm	VIE0518-0050-I	51803
Inox	64mm	100mm	VIE0518-0100-I	51808
Inox	128mm	200mm	VIE0518-0200-I	51813
Inox	320mm	400mm	VIE0518-0400-I	51818
Inox	368/736mm	800mm	VIE0518-0800-I	51823
Inox	352/1056mm	1100mm	VIE0518-1100-I	51828
Wit	32mm	50mm	VIE0518-0050-W	51804
Wit	64mm	100mm	VIE0518-0100-W	51809
Wit	128mm	200mm	VIE0518-0200-W	51814
Wit	320mm	400mm	VIE0518-0400-W	51819
Wit	368/736mm	800mm	VIE0518-0800-W	51824
Wit	352/1056mm	1100mm	VIE0518-1100-W	51829
Zwart	32mm	50mm	VIE0518-0050-Z	51805
Zwart	64mm	100mm	VIE0518-0100-Z	51810
Zwart	128mm	200mm	VIE0518-0200-Z	51815
Zwart	320mm	400mm	VIE0518-0400-Z	51820
Zwart	368/736mm	800mm	VIE0518-0800-Z	51825
Zwart	352/1056mm	1100mm	VIE0518-1100-Z	51830



TRIM opzetgreep inox look

LENGTE	FRONTMAAT	BREEDTE	HOOGTE	BEVESTIGING	ARTIKEL NR.	SNELCODE
295mm	300mm	10/13mm	20/38mm	Infrezen	0706FP40829566	01060
345mm	350mm	10/13mm	20/38mm	Infrezen	0706FP40834566	02060
395mm	400mm	10/13mm	20/38mm	Infrezen	0706FP40839566	03060
445mm	450mm	10/13mm	20/38mm	Infrezen	0706FP40844566	04060
495mm	500mm	10/13mm	20/38mm	Infrezen	0706FP40849566	05060
595mm	600mm	10/13mm	20/38mm	Infrezen	0706FP40859566	06060
795mm	800mm	10/13mm	20/38mm	Infrezen	0706FP40879566	07060
895mm	900mm	10/13mm	20/38mm	Infrezen	0706FP40889566	08060
995mm	1000mm	10/13mm	20/38mm	Infrezen	0706FP40899566	09060
1195mm	1200mm	10/13mm	20/38mm	Infrezen	0706FP408119566	10060



TRIM opzetgreep mat zwart

LENGTE	FRONTMAAT	BREEDTE	HOOGTE	BEVESTIGING	ARTIKEL NR.	SNELCODE
295mm	300mm	10/13mm	20/38mm	Infrezen	0706FP40829576	40871
395mm	400mm	10/13mm	20/38mm	Infrezen	0706FP40839576	40873
445mm	450mm	10/13mm	20/38mm	Infrezen	0706FP40844576	40874
495mm	500mm	10/13mm	20/38mm	Infrezen	0706FP40849576	40875
595mm	600mm	10/13mm	20/38mm	Infrezen	0706FP40859576	40876
795mm	800mm	10/13mm	20/38mm	Infrezen	0706FP40879576	40877
895mm	900mm	10/13mm	20/38mm	Infrezen	0706FP40889576	40878
995mm	1000mm	10/13mm	20/38mm	Infrezen	0706FP40899576	40879
1195mm	1200mm	10/13mm	20/38mm	Infrezen	0706FP408119576	40880

Technische Fiche

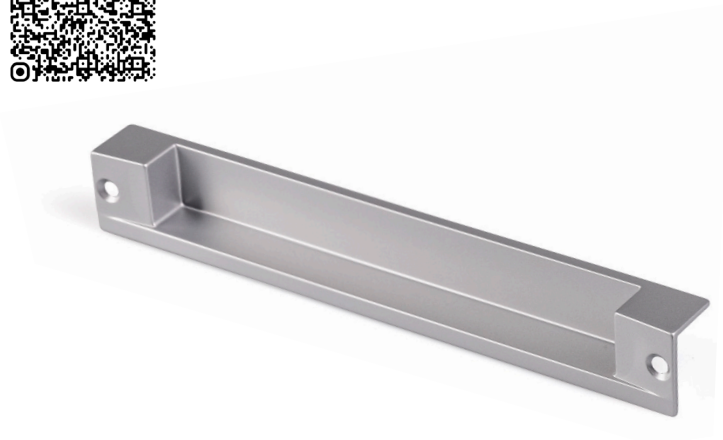

SEIZE infreesgreep alu kleur

BOORAFSTAND	OVERMETEN	ARTIKEL NR.	SNELCODE
170mm	180mm	0706V3730.021	01058

Technische Fiche



BACK infreesgreep inox look

BOORAFSTAND	OVERMETEN	HOOGTE X BREEDTE	BEVESTIGING	ARTIKEL NR.	SNELCODE
64mm	112mm	16x20mm	Frezing	0706FP515560064	02058
128mm	200mm	15x20mm	Frezing	0706FP515560128	03058



L-GREEP chromé mat

BOORAFSTAND	OVERMETEN	BEVESTIGING	ARTIKEL NR.	SNELCODE
32mm	38x45mm	Houtvijs	0706GR8849531	01066

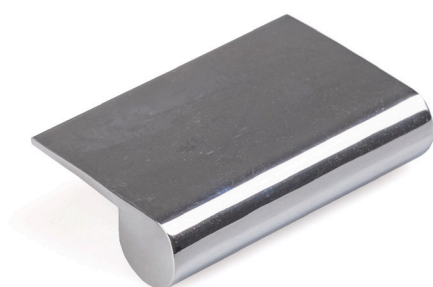

SPIEGELGREEP chromé

OVERMETEN	BEVESTIGING	ARTIKEL NR.	SNELCODE
50x31mm	Kleefband	0706GR8640829	02066



INFREESGREEP 903 infreesgreep

UITVOERING	OVERMETEN	BEVESTIGING	ARTIKEL NR.	SNELCODE
Zwart	40X120mm	houtvijs + frezing	0730 9030120ZW	03125

Moderne & klassieke knoppen

Ze bepalen het cachet van het meubel en bieden een meerwaarde aan het design. Wij stellen onze collectie steeds samen op basis van de ervaringen met onze klanten. Momenteel heerst er een zeer sterke trend naar zwarte knoppen maar ook de mat gouden knoppen in combinatie met eiken accenten lijken erg terug in trek. In ons nieuwe programma moderne en klassieke knoppen houden we hier al rekening mee en hebben we verschillende nieuwe modellen toegevoegd.

Technische Fiche



DISC knop zamak

UITVOERING	DIAMETER	HOOGTE	BEVESTIGING	ARTIKEL NR.	SNELCODE
Messing	38mm	21mm	M4	VIE0530-38-GM	53001
Nikkel	38mm	21mm	M4	VIE0530-38-NI	53002
Mat wit	38mm	21mm	M4	VIE0530-38-WI	53003
Mat zwart	38mm	21mm	M4	VIE0530-38-ZW	53004
Messing	50mm	27mm	M4	VIE0530-50-GM	53005
Nikkel	50mm	27mm	M4	VIE0530-50-NI	53006
Mat wit	50mm	27mm	M4	VIE0530-50-WI	53007
Mat zwart	50mm	27mm	M4	VIE0530-50-ZW	53008

Technische Fiche



Oh! knop zamak

UITVOERING	DIAMETER	HOOGTE	BEVESTIGING	ARTIKEL NR.	SNELCODE
Nikkel	40mm	26mm	M4	VIE0601-40-NIK	60104
Messing	40mm	26mm	M4	VIE0601-40-MES	60105
Mat zwart	40mm	26mm	M4	VIE0601-40-ZW	60106

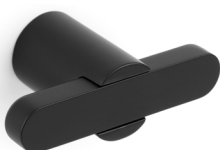
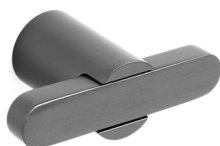

FUSION glans zamak

UITVOERING	OVERMETEN	HOOGTE	BEVESTIGING	ARTIKEL NR.	SNELCODE
Titanium zwart	58mm	32mm	M4	VIE0627058-ZN	62701
Nikkel	58mm	32mm	M4	VIE0627058-GN	62702
Messing	58mm	32mm	M4	VIE0627058-GMES	62703

FUSION mat zamak

UITVOERING	OVERMETEN	HOOGTE	BEVESTIGING	ARTIKEL NR.	SNELCODE
Titanium zwart	58mm	32mm	M4	VIE0627058-MN	62704
Zwart	58mm	32mm	M4	VIE0627058-MZ	62706
Messing	58mm	32mm	M4	VIE0627058-MES	62705

Knop inclusief extra punt om doordraaien te vermijden

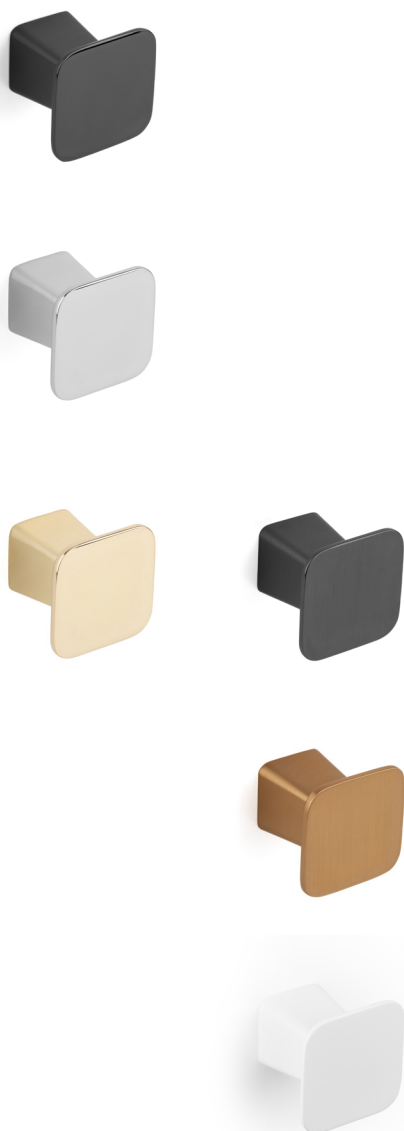

D

PRISM glans zamak

UITVOERING	AFMETINGEN	HOOGTE	BEVESTIGING	ARTIKEL NR.	SNELCODE
Titanium zwart	32x32mm	28mm	M4	VIE0638032-ZN	63801
Nikkel	32x32mm	28mm	M4	VIE0638032-GN	63802
Messing	32x32mm	28mm	M4	VIE0638032-GMES	63803

PRISM mat zamak

UITVOERING	AFMETINGEN	HOOGTE	BEVESTIGING	ARTIKEL NR.	SNELCODE
Titanium zwart	32x32mm	28mm	M4	VIE0638032-MN	63804
Messing	32x32mm	28mm	M4	VIE0638032-MES	63805
Wit	32x32mm	28mm	M4	VIE0638032-MW	63806

Knop inclusief extra punt om doordraaien te vermijden

D MODERNE EN KLASSIEKE KNOPPEN



PLATO knop

UITVOERING	DIAMETER	HOOGTE	BEVESTIGING	ARTIKEL NR.	SNELCODE
Antraciet grijs	42mm	24mm	M4 vijs	0706FP4413042AN	03066
Inox look	42mm	24mm	M4 vijs	0706FP4413042IL	04066
Messing	42mm	24mm	M4 vijs	0706FP4413042ME	05066
Mat zwart	42mm	24mm	M4 vijs	0706FP4413042ZW	06066

Technische Fiche



EQUIS knop

UITVOERING	DIAMETER	HOOGTE	BEVESTIGING	ARTIKEL NR.	SNELCODE
Chrome glans	40x40mm	25mm	M4	VIE0614-40-CG	61403
Koper	40x40mm	25mm	M4	VIE0614-40-KOP	61405
Messing	40x40mm	25mm	M4	VIE0614-40-MG	61406
Mat wit	40x40mm	25mm	M4	VIE0614-40-MW	61402
Mat zwart	40x40mm	25mm	M4	VIE0614-40-MZ	61401
Glans zwart	40x40mm	25mm	M4	VIE0614-40-ZN	61404

Ook beschikbaar als kapstokhaak, zie pagina J 4.

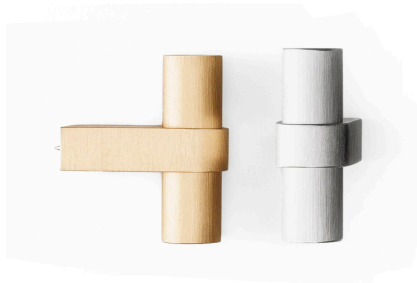

NOBB knop aluminium

UITVOERING	OVERMETEN	HOOGTE	BEVESTIGING	ARTIKEL NR.	SNELCODE
Inox look	52mm	45mm	M4	VIE0657-0052-IL	65701
Zwart	52mm	45mm	M4	VIE0657-0052-ZW	65702
Messing	52mm	45mm	M4	VIE0657-0052-MES	65703

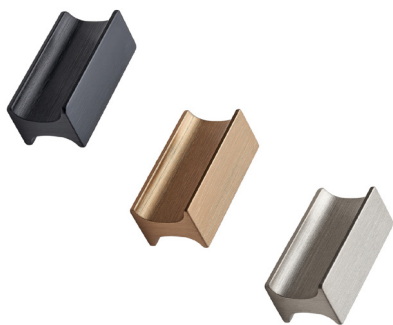

TRACK knop aluminium

UITVOERING	BOORAFSTAND	OVERMETEN	HOOGTE	BEVESTIGING	ARTIKEL NR.	SNELCODE
Messing geborsteld	32mm	50mm	24mm	M4	0706FP45702-32-MES	45710
Inox look	32mm	50mm	24mm	M4	0706FP45702-32-IL	45711
Mat zwart	32mm	50mm	24mm	M4	0706FP45702-32-ZW	45712



Brutus knop hout

UITVOERING	DIAMETER	HOOGTE	BEVESTIGING	ARTIKEL NR.	SNELCODE
Eik vernist	32mm	25mm	M4	0706FP106220032-EIK	10615
Walnoot vernist	32mm	25mm	M4	0706FP106220032-NOO	10616
Zwart gekleurd	32mm	25mm	M4	0706FP106220032-ZW	10617



Classis knop hout

UITVOERING	DIAMETER	HOOGTE	BEVESTIGING	ARTIKEL NR.	SNELCODE
Eik vernist	25mm	22mm	M4	0706FP106920025-EIK	10621
Walnoot vernist	25mm	22mm	M4	0706FP106920025-NOO	10622
Zwart gekleurd	25mm	22mm	M4	0706FP106920025-ZW	10623

D

D MODERNE EN KLASSIEKE KNOPPEN

Technische Fiche



COMO knop zamak

UITVOERING	DIAMETER	HOOGTE	BEVESTIGING	ARTIKEL NR.	SNELCODE
Chromé glans	26mm	18mm	M4 vijs	VIE0168-26-CHR	16801
Goud	26mm	18mm	M4 vijs	VIE0168-26-GOU	16804
Inox look	26mm	18mm	M4 vijs	VIE0168-26-IL	16802
Koper	26mm	18mm	M4 vijs	VIE0168-26-KOP	16803
Mat wit	26mm	18mm	M4 vijs	VIE0168-26-WIT	16805
Mat zwart	26mm	18mm	M4 vijs	VIE0168-26-ZWA	16806
Chromé glans	41mm	25mm	M4 vijs	VIE0168-41-CHR	16807
Goud	41mm	25mm	M4 vijs	VIE0168-41-GOU	16810
Inox look	41mm	25mm	M4 vijs	VIE0168-41-IL	16808
Koper	41mm	25mm	M4 vijs	VIE0168-41-KOP	16809
Mat wit	41mm	25mm	M4 vijs	VIE0168-41-WIT	16811
Mat zwart	41mm	25mm	M4 vijs	VIE0168-41-ZWA	16812

Tip! Ook beschikbaar als kapstokhaak, zie pagina J 9



D

DUKE knop zamak

UITVOERING	DIAMETER	HOOGTE	BEVESTIGING	ARTIKEL NR.	SNELCODE
Chromé glans	32mm	26mm	M4 vjjs	VIE0393-31-CHR	39301
Goud	32mm	26mm	M4 vjjs	VIE0393-31-GOU	39304
Inox look	32mm	26mm	M4 vjjs	VIE0393-31-IL	39302
Koper	32mm	26mm	M4 vjjs	VIE0393-31-KOP	39303
Mat wit	32mm	26mm	M4 vjjs	VIE0393-31-WIT	39305
Mat zwart	32mm	26mm	M4 vjjs	VIE0393-31-ZWA	39306

D MODERNE EN KLASSIEKE KNOPPEN



GRAF MINI knop

UITVOERING	DIAMETER	HOOGTE	BEVESTIGING	ARTIKEL NR.	SNELCODE
Zwart	10mm	33mm	M4 vijs	VIE430-10-ZW	43014
Messing	10mm	33mm	M4 vijs	VIE430-10-MS	43009
Inox look	10mm	33mm	M4 vijs	VIE430-10-IXL	43004

GRAF T-knop

UITVOERING	OVERMETEN	HOOGTE	BEVESTIGING	ARTIKEL NR.	SNELCODE
Zwart	60mm	33mm	M4 vijs	VIE430-60-ZW	43015
Messing	60mm	33mm	M4 vijs	VIE430-60-MS	43010
Inox look	60mm	33mm	M4 vijs	VIE430-60-IXL	43005

GRAF BIG knop

UITVOERING	DIAMETER	HOOGTE	BEVESTIGING	ARTIKEL NR.	SNELCODE
Zwart	50mm	30mm	M4 vijs	VIE0486-50-ZW	48640
Messing	50mm	30mm	M4 vijs	VIE0486-50-MS	48641
Inox look	50mm	30mm	M4 vijs	VIE0486-50-IL	48643



D

SAFARI lederen knop - inox look

UITVOERING	BOORAFSTAND	LENGTE	BREEDTE	HOOGTE	BEVESTIGING	ARTIKEL NR.	SNELCODE
Cognac	16mm	67mm	24mm	25mm	M4 vijzen	0706FP5381-105	53814



BELL knop

KLEUR	DIAMETER	HOOGTE	BEVESTIGING	ARTIKEL NR.	SNELCODE
Antiek grijs	42mm	32mm	M4 vijs	0706FP540842-22	14120
Antiek bruin	42mm	32mm	M4 vijs	0706FP540842-23	15120
Inox look	42mm	32mm	M4 vijs	0706FP540842-66	16120
Mat zwart	42mm	32mm	M4 vijs	0706FP540842-99	17120

D MODERNE EN KLASSIEKE KNOPPEN



KNOT knop

UITVOERING	BREEDTE	HOOGTE	BEVESTIGING	ARTIKEL NR.	SNELCODE
Inox	75mm	44mm	M4 vijs	0706FP238030075	01077
Zwart	75mm	44mm	M4 vijs	0706FP2380375ZW	08077



HARLEQUIN knop

UITVOERING	DIAMETER	HOOGTE	BEVESTIGING	ARTIKEL NR.	SNELCODE
Inox	17mm	33mm	M4 vijs	0706FP240717-IN	05044
Zwart	17mm	33mm	M4 vijs	0706FP240717-ZW	06044



KRAANKNOP inox

UITVOERING	OVERMETEN	HOOGTE	BEVESTIGING	ARTIKEL NR.	SNELCODE
Inox	50mm	40mm	M4 vijs	0706FP224230050	02076

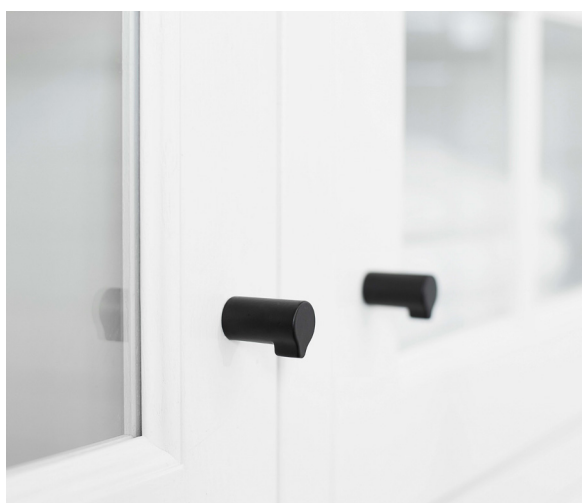
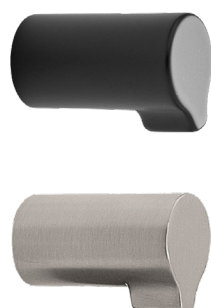

SCOPE knop

UITVOERING	DIAMETER	HOOGTE	BEVESTIGING	ARTIKEL NR.	SNELCODE
Inox look	16mm	30mm	M4 vijs	0706FP543KN-IL	04034
Zwart	16mm	30mm	M4 vijs	0706FP543KN-ZW	05034

D MODERNE EN KLASSIEKE KNOPPEN

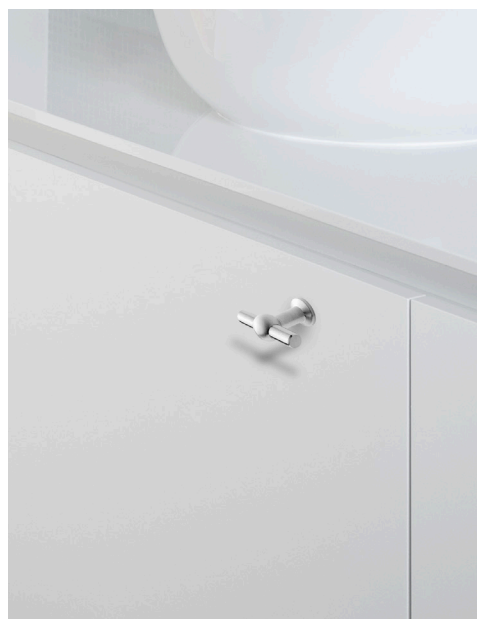

KRAAN knop

UITVOERING	OVERMETEN	HOOGTE	BEVESTIGING	ARTIKEL NR.	SNELCODE
Inox look	50mm	40mm	M4 vijs	0706GR72395019	01076

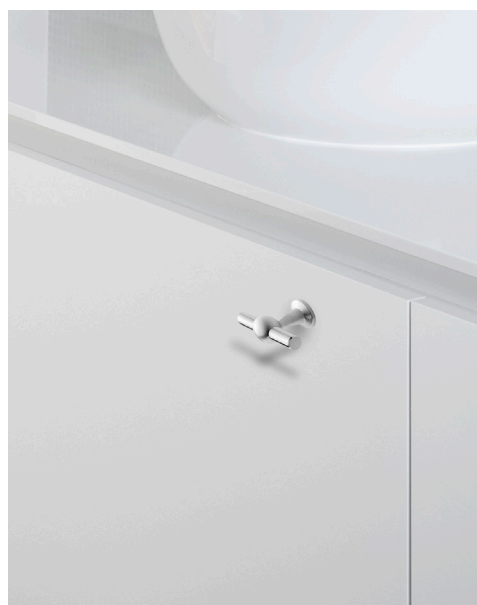

KRAAN knop inox look + pin

UITVOERING	OVERMETEN	HOOGTE	BEVESTIGING	ARTIKEL NR.	SNELCODE
Inox look	45mm	35mm	M4 vijs	FW36849-001+PIN	36849



D

MUSHROOM knop

UITVOERING	DIAMETER	HOOGTE	BEVESTIGING	ARTIKEL NR.	SNELCODE
Inox look	22mm	22mm	M4 vijs	0706FP216810022	01075

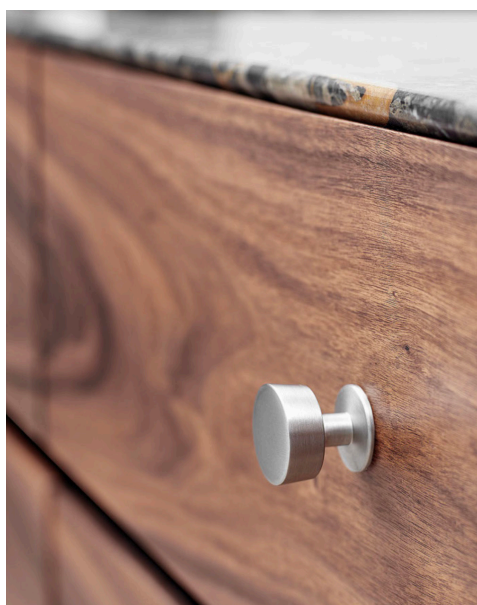
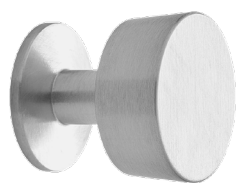

BOBBIN knop

UITVOERING	DIAMETER	HOOGTE	BEVESTIGING	ARTIKEL NR.	SNELCODE
Inox look	25mm	24mm	M4 vijs	0706FP208610025	03075

D MODERNE EN KLASSIEKE KNOPPEN

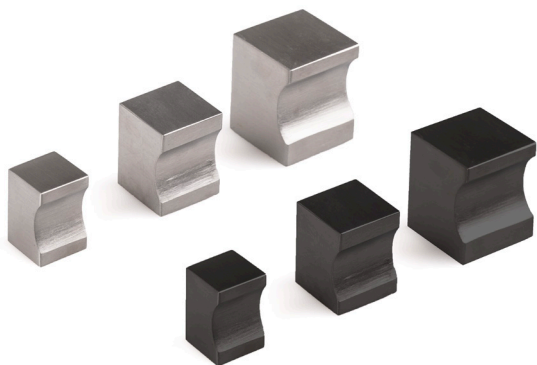

QUADRO knop

UITVOERING	AFMETINGEN	HOOGTE	BEVESTIGING	ARTIKEL NR.	SNELCODE
Inox	15x15mm	20mm	M4 vijs	0706 FH319.15	01068
Inox	20x20mm	25mm	M4 vijs	0706 FH319.20	02068
Inox	25x25mm	30mm	M4 vijs	0706 FH319.25	03068
Mat zwart	15x15mm	20mm	M4 vijs	0706 FH319.15ZW	04068
Mat zwart	20x20mm	25mm	M4 vijs	0706 FH319.20ZW	05068
Mat zwart	25x25mm	30mm	M4 vijs	0706 FH319.25ZW	06068

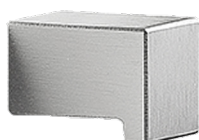

BYTE knop

UITVOERING	DIAMETER	HOOGTE	BEVESTIGING	ARTIKEL NR.	SNELCODE
Inox look	19mm	25mm	M4 vijs	0706FP22519-IN	03074



D

RONDO knop

UITVOERING	DIAMETER	HOOGTE	BEVESTIGING	ARTIKEL NR.	SNELCODE
Aluminium	12mm	20mm	M4 vjjs	0706GR72052347	01067
Aluminium	15mm	22mm	M4 vjjs	0706GR72052247	02067
Aluminium	18mm	25mm	M4 vjjs	0706GR72052147	03067
Aluminium	21mm	27mm	M4 vjjs	0706GR72052047	04067
Inox	12mm	20mm	M4 vjjs	0706GR72052317	05067
Inox	15mm	22mm	M4 vjjs	0706GR72052217	06067
Inox	18mm	25mm	M4 vjjs	0706GR72052117	07067
Inox	21mm	27mm	M4 vjjs	0706GR72052017	08067
Mat zwart	15mm	26mm	M4 vjjs	0706 FH302-15Z	21918
Mat zwart	20mm	28mm	M4 vjjs	0706 FH302-20Z	21921
Mat zwart	25mm	30mm	M4 vjjs	0706 FH302-25Z	21923

D MODERNE EN KLASSIEKE KNOPPEN

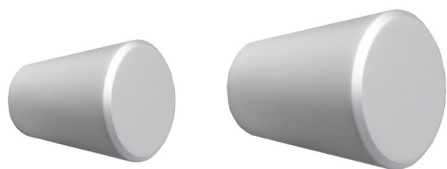

PYRA knop

UITVOERING	DIAMETER	HOOGTE	BEVESTIGING	ARTIKEL NR.	SNELCODE
Aluminium	20mm	25mm	M4 vijs	0706GR72157547	01069
Aluminium	24mm	29mm	M4 vijs	0706GR72157647	02069
Inox	20mm	25mm	M4 vijs	0706GR72157517	05069
Inox	24mm	30mm	M4 vijs	0706GR72157617	06069
Inox	29mm	35mm	M4 vijs	0706GR72157817	07069

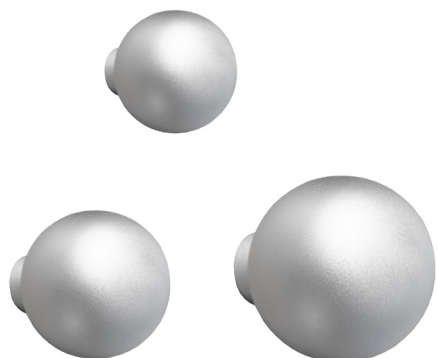

D

BOL knop

UITVOERING	DIAMETER	HOOGTE	BEVESTIGING	ARTIKEL NR.	SNELCODE
Aluminium	20mm	22mm	M4 vijs	0706GR72211047	01070
Aluminium	25mm	27mm	M4 vijs	0706GR72211147	02070
Aluminium	30mm	32mm	M4 vijs	0706GR72211247	03070
Inox	20mm	22mm	M4 vijs	0706GR72211017	04070
Inox	25mm	27mm	M4 vijs	0706GR72211117	05070
Inox	30mm	32mm	M4 vijs	0706GR72211217	06070

D MODERNE EN KLASSIEKE KNOPPEN



PILLAR knop

UITVOERING	DIAMETER	HOOGTE	BEVESTIGING	ARTIKEL NR.	SNELCODE
Mat zwart	15mm	33mm	M4 vijls	0706FP547772-99	54773



BOXX knop

UITVOERING	AFMETINGEN	HOOGTE	BEVESTIGING	ARTIKEL NR.	SNELCODE
Inox look	15x15mm	25mm	M4 vijls	VIE0097-15-IL	97002
Mat zwart	15x15mm	25mm	M4 vijls	VIE0097-15-ZWA	97001

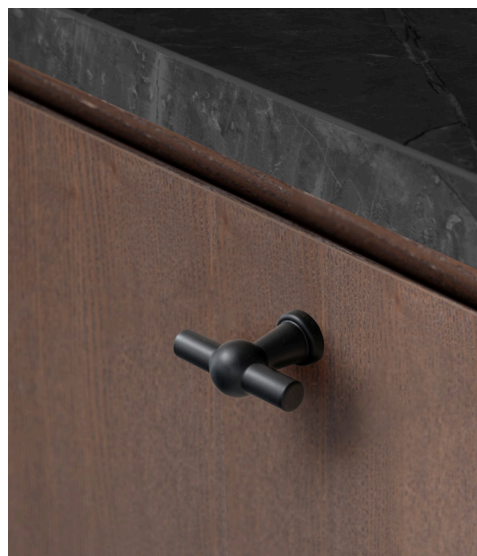

D

PETRA knop 46mm

UITVOERING	BREEDTE	HOOGTE	BEVESTIGING	ARTIKEL NR.	SNELBESTELCODE
Zwart	46mm	35mm	M4 vijs	HDD 2.129.090	21290



PETRA greep 96mm

UITVOERING	BOORAFSTAND	OVERMETEN	HOOGTE	BEVESTIGING	ARTIKEL NR.	SNELBESTELCODE
Zwart	96mm	120mm	35mm	M4 vijs	HDD 2.263.090	22630

D

MODERNE EN KLASSIEKE KNOPPEN



OVAL SIMPLE knop

UITVOERING	DIAMETER	HOOGTE	BREEDTE	BEVESTIGING	ARTIKEL NR.	SNELCODE
Inox look	60mm	38mm	35mm	M4 vijs	0706FP5250060IL	01073

Houten knoppen & grepen

Hout straalt warmte en gezelligheid uit. Soms wil je dit nog extra benadrukken door ook een houten knop of greep op je meubel te plaatsen. Deze collectie beantwoordt hier aan en kan een meerwaarde betekenen voor verschillende meubel toepassingen, zowel in badkamer, keuken, kantoor, leefruimte of slaapkamer. De vormen zijn hedendaags, de uitvoeringen actueel en sluiten nauw aan bij de nieuwe Japandi keukenstijl die Scandinavische vormgeving combineert met Oosterse tinten.



Brutus knop

UITVOERING	DIAMETER	HOOGTE	BEVESTIGING	ARTIKEL NR.	SNELCODE
Eik vernist	32mm	25mm	M4	0706FP106220032-EIK	10615
Walnoot vernist	32mm	25mm	M4	0706FP106220032-NOO	10616
Zwart gekleurd	32mm	25mm	M4	0706FP106220032-ZW	10617

Brutus greep

UITVOERING	BOORAFSTAND	OVERMETEN	HOOGTE	BEVESTIGING	ARTIKEL NR.	SNELCODE
Eik vernist	160mm	224mm	28mm	M4	0706FP106120160-EIK	10612
Walnoot vernist	160mm	224mm	28mm	M4	0706FP106120160-NOO	10613
Zwart gekleurd	160mm	224mm	28mm	M4	0706FP106120160-ZW	10614



Classis knop

UITVOERING	DIAMETER	HOOGTE	BEVESTIGING	ARTIKEL NR.	SNELCODE
Eik vernist	25mm	22mm	M4	0706FP106920025-EIK	10621
Walnoot vernist	25mm	22mm	M4	0706FP106920025-NOO	10622
Zwart gekleurd	25mm	22mm	M4	0706FP106920025-ZW	10623

Classis greep

UITVOERING	BOORAFSTAND	OVERMETEN	HOOGTE	BEVESTIGING	ARTIKEL NR.	SNELCODE
Eik vernist	160mm	203mm	22mm	M4	0706FP106820160-EIK	10618
Walnoot vernist	160mm	203mm	22mm	M4	0706FP106820160-NOO	10619
Zwart gekleurd	160mm	203mm	22mm	M4	0706FP106820160-ZW	10620

E



Japan greep

UITVOERING	BOORAFSTAND	OVERMETEN	HOOGTE	BEVESTIGING	ARTIKEL NR.	SNELCODE
Eik vernist	160mm	384mm	32mm	M4	0706FP117760160-EIK	11701
Walnoot vernist	160mm	384mm	32mm	M4	0706FP117760160-NOO	11702
Zwart gekleurd	160mm	384mm	32mm	M4	0706FP117760160-ZW	11703
Eik vernist	224mm	448mm	32mm	M4	0706FP117760224-EIK	11704
Walnoot vernist	224mm	448mm	32mm	M4	0706FP117760224-NOO	11705
Zwart gekleurd	224mm	448mm	32mm	M4	0706FP117760224-ZW	11706

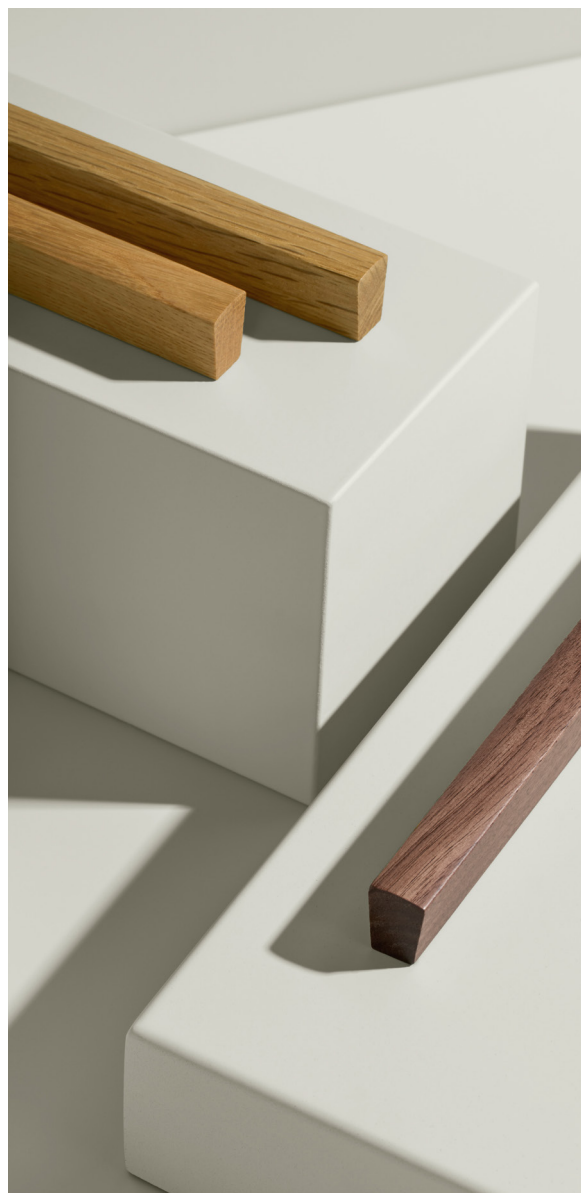

E

TRIM greep

UITVOERING	BOORAFSTAND	OVERMETEN	HOOGTE	BEVESTIGING	ARTIKEL NR.	SNELCODE
Eik vernist	128mm	168mm	20mm	M4	0706FP104920128-EIK	14101
Walnoot vernist	128mm	168mm	20mm	M4	0706FP104920128-NOO	14102
Zwart gekleurd	128mm	168mm	20mm	M4	0706FP104920128-ZW	14103
Eik vernist	160mm	200mm	20mm	M4	0706FP104920160-EIK	14104
Walnoot vernist	160mm	200mm	20mm	M4	0706FP104920160-NOO	14105
Zwart gekleurd	160mm	200mm	20mm	M4	0706FP104920160-ZW	14106
Eik vernist	224mm	264mm	20mm	M4	0706FP104920224-EIK	14107
Walnoot vernist	224mm	264mm	20mm	M4	0706FP104920224-NOO	14108
Zwart gekleurd	224mm	264mm	20mm	M4	0706FP104920224-ZW	14109



Tuba knop

UITVOERING	DIAMETER	HOOGTE	BEVESTIGING	ARTIKEL NR.	SNELCODE
Eik vernist	28mm	19mm	M4	0706FP109120028-EIK	10907
Walnoot vernist	28mm	19mm	M4	0706FP109120028-NOO	10908
Zwart gekleurd	28mm	19mm	M4	0706FP109120028-ZW	10909

Tuba greep

UITVOERING	BOORAFSTAND	OVERMETEN	HOOGTE	BEVESTIGING	ARTIKEL NR.	SNELCODE
Eik vernist	128mm	156mm	28mm	M4	0706FP109020128-EIK	10901
Walnoot vernist	128mm	156mm	28mm	M4	0706FP109020128-NOO	10902
Zwart gekleurd	128mm	156mm	28mm	M4	0706FP109020128-ZW	10903
Eik vernist	256mm	284mm	28mm	M4	0706FP109020256-EIK	10904
Walnoot vernist	256mm	284mm	28mm	M4	0706FP109020256-NOO	10905
Zwart gekleurd	256mm	284mm	28mm	M4	0706FP1090256-ZW	10906

Technische Fiche



FLAPP Wood greep

UITVOERING	BOORAFSTAND	OVERMETEN	HOOGTE	BREEDTE	BEVESTIGING	ARTIKEL NR.	SNELCODE
Eik brut	32mm	70mm	22mm	24mm	M4	VIE0613-070-EIKB	61301
Eik vernis	32mm	70mm	22mm	24mm	M4	VIE0613-070-EIKV	61302
Walnoot	32mm	70mm	22mm	24mm	M4	VIE0613-070-NOOT	61303
Eik brut	160mm	200mm	22mm	24mm	M4	VIE0613-200-EIKB	61304
Eik vernis	160mm	200mm	22mm	24mm	M4	VIE0613-200-EIKV	61305
Walnoot	160mm	200mm	22mm	24mm	M4	VIE0613-200-NOOT	61306
Eik brut	416/1056mm	1100mm	22mm	24mm	M4	VIE0613-1100-EIKB	61307
Eik vernis	416/1056mm	1100mm	22mm	24mm	M4	VIE0613-1100-EIKV	61308
Walnoot	416/1056mm	1100mm	22mm	24mm	M4	VIE0613-1100-NOOT	61309

E



TRACK greep

UITVOERING	BOORAFSTAND	OVERMETEN	HOOGTE	BEVESTIGING	ARTIKEL NR.	SNELCODE
Eik vernist	160mm	200mm	24mm	M4	0706FP10372-160-EIK	10371
Eik verzwart	160mm	200mm	24mm	M4	0706FP10372-160-ZW	10372



MANTA Mini knop

UITVOERING	BOORAFSTAND	OVERMETEN	HOOGTE	BEVESTIGING	ARTIKEL NR.	SNELBESTELCODE
Eik	32mm	80mm	26mm	M4 vijs	0706FP1013032EI	01012
Walnoot	32mm	80mm	26mm	M4 vijs	0706FP1013032NO	02012

MANTA greep

UITVOERING	BOORAFSTAND	OVERMETEN	HOOGTE	BEVESTIGING	ARTIKEL NR.	SNELBESTELCODE
Eik	160mm	240mm	26mm	M4 vijs	0706FP1013160EI	03012
Walnoot	160mm	240mm	26mm	M4 vijs	0706FP1013160NO	04012

E

E HOUTEN KNOPPEN EN GREPEN



ECHO knop

UITVOERING	DIAMETER	HOOGTE	BEVESTIGING	ARTIKEL NR.	SNELBESTELCODE
Wit geborsteld	60mm	22mm	M4 vijs	VIE0166-60-WIT	16601
Bruin geborsteld	60mm	22mm	M4 vijs	VIE0166-60-BRU	16602
Zwart geborsteld	60mm	22mm	M4 vijs	VIE0166-60-ZWA	16603



KNOP 958

UITVOERING	DIAMETER	HOOGTE	BEVESTIGING	ARTIKEL NR.	SNELBESTELCODE
Beuk blank	30mm	26mm	M4 vijs	0730 958-30 B	01121
Beuk blank	39mm	30mm	M4 vijs	0730 958-39 B	02121



CALIN greep

UITVOERING	BOORAFSTAND	OVERMETEN	HOOGTE	BEVESTIGING	ARTIKEL NR.	SNELBESTELCODE
Wit geborsteld	160mm	240mm	30mm	M4 vijs	VIE0165-160-WIT	16501
Bruin geborsteld	160mm	240mm	30mm	M4 vijs	VIE0165-160-BRU	16502
Zwart geborsteld	160mm	240mm	30mm	M4 vijs	VIE0165-160-ZWA	16503

NIEUW!

Technische Fiche



Oh! Wood knop

UITVOERING	DIAMETER	HOOGTE	BEVESTIGING	ARTIKEL NR.	SNELCODE
Eik	40mm	26mm	M4	VIE0601-40-EIK	60101
Walnoot	40mm	26mm	M4	VIE0601-40-NOOT	60102
Mat zwart	40mm	26mm	M4	VIE0601-40-ZWART	60103

Black & White collection

De belangrijkste knoppen en grepen in zowel zwart als wit hebben we opnieuw samen gebracht in dit hoofdstuk om het zoeken te vergemakkelijken. Vooral de zwarte uitvoering is momenteel in de BENELUX zeer gegeerd en gezien het tijdloze karakter van zwart, kunt u hier niets fout mee doen. Ondertussen is er ook een uitgebreid programma technisch beslag verkrijgbaar in zwart zoals potscharnieren, kleerkastbuizen enz.... Deze trend is nooit weg geweest en zal ook nooit meer verdwijnen.

Technische Fiche



U greep

UITVOERING	BOORAFSTAND	OVERMETEN	HOOGTE	BEVESTIGING	ARTIKEL NR.	SNELCODE
Mat wit	128mm	137mm	29mm	M4	VIE0056-128-WI	56007
Mat wit	160mm	169mm	29mm	M4	VIE0056-160-WI	56015
Mat wit	192mm	201mm	29mm	M4	VIE0056-192-WI	56023
Mat wit	320mm	329mm	29mm	M4	VIE0056-320-WI	56031
Mat wit	492mm	501mm	29mm	M4	VIE0056-492-WI	56039
Mat zwart	128mm	137mm	29mm	M4	VIE0056-128-ZW	56008
Mat zwart	160mm	169mm	29mm	M4	VIE0056-160-ZW	56016
Mat zwart	192mm	201mm	29mm	M4	VIE0056-192-ZW	56024
Mat zwart	320mm	329mm	29mm	M4	VIE0056-320-ZW	56032
Mat zwart	492mm	501mm	29mm	M4	VIE0056-492-ZW	56040

Technische Fiche

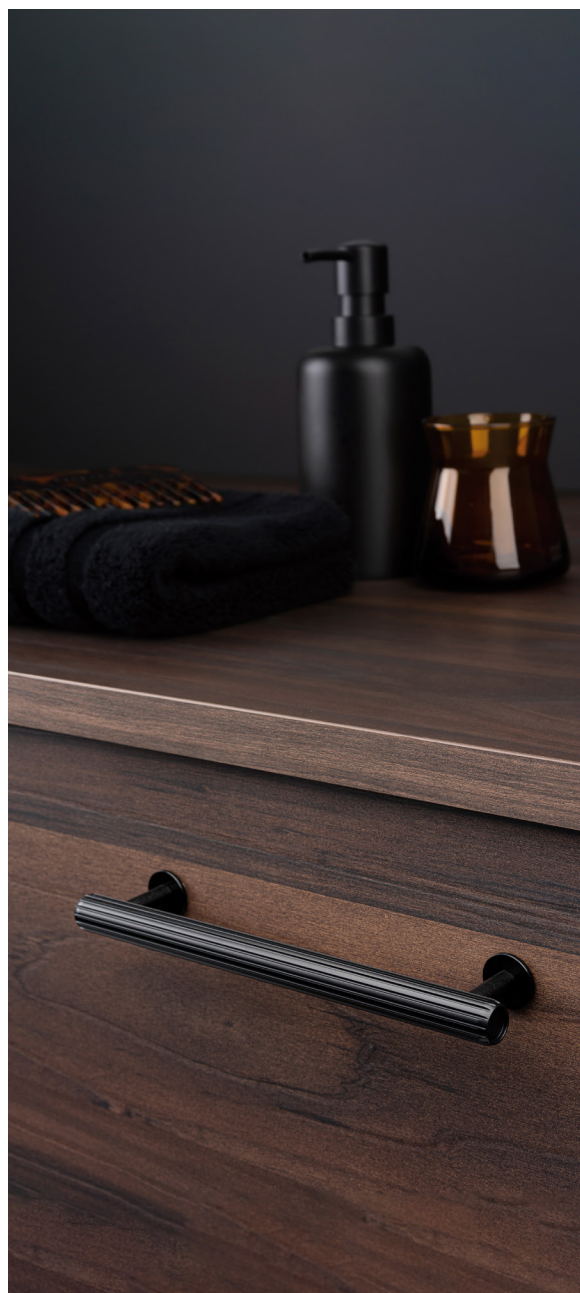

RILLE knop & greep aluminium

UITVOERING	BOORAFSTAND	OVERMETEN	HOOGTE	BEVESTIGING	ARTIKEL NR.	SNELCODE
Zwart	/	55mm	39mm	M4	VIE0528-55-ZW	52803
Zwart	160mm	190mm	39mm	M4	VIE0528-160-ZW	52806
Zwart	320mm	350mm	39mm	M4	VIE0528-320-ZW	52809
Zwart	480mm	510mm	39mm	M4	VIE0528-480-ZW	52812
Zwart	496/992mm	1022mm	39mm	M4	VIE0528-992-ZW	52815

Technische Fiche

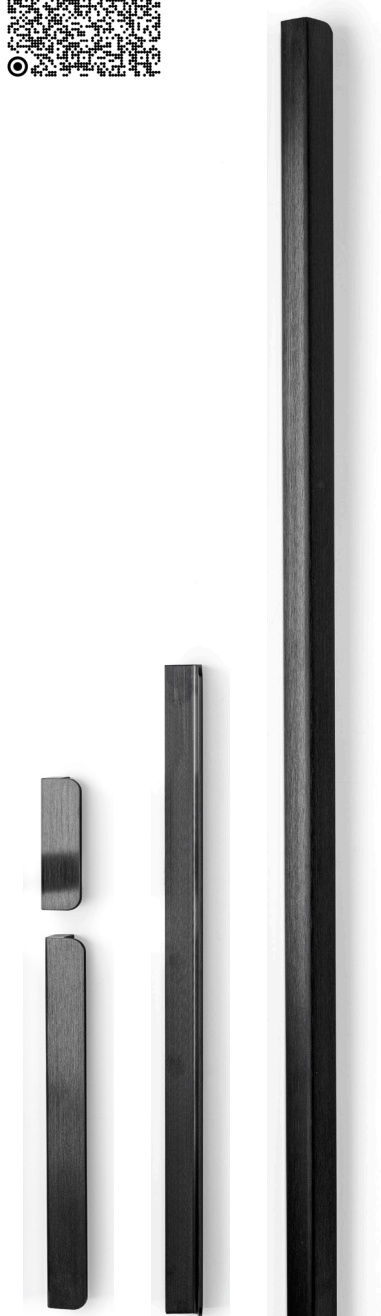

FLAPP greep aluminium

UITVOERING	BOORAFSTAND	OVERMETEN	HOOGTE	BEVESTIGING	ARTIKEL NR.	SNELCODE
Zwart mat	32mm	70mm	22mm	M4	VIE0610-070-ZM	61005
Zwart mat	128 / 160mm	200mm	22mm	M4	VIE0610-160-ZM	61001
Zwart mat	256mm	350mm	22mm	M4	VIE0610-350-ZM	61008
Zwart mat	416 / 1056mm	1100mm	22mm	M4	VIE0610-1100-ZM	61011



GRAF knop & greep

ARTIKEL	UITVOERING	OVERMETEN	HOOGTE	BEVESTIGING	ARTIKEL NR.	SNELCODE
Graf big knop	Zwart	Ø 50mm	30mm	M4	VIE0486-50-ZW	48640
Graf mini knop	Zwart	10mm	33mm	M4	VIE430-10-ZW	43014
Graf T-knop	Zwart	60mm	33mm	M4	VIE430-60-ZW	43015

ARTIKEL	UITVOERING	BOORAFSTAND	OVERMETEN	HOOGTE	BEVESTIGING	ARTIKEL NR.	SNELCODE
Greep	Zwart	160mm	182mm	33mm	M4	VIE430-182-ZW	43011
Greep	Zwart	256mm	278mm	33mm	M4	VIE430-278-ZW	43012
Greep	Zwart	589 / 1178mm	1200mm	33mm	M4	VIE430-1200-ZW	43013

Technische Fiche



BELT knop & greep zamak

ARTIKEL	UITVOERING	AFMETINGEN	HOOGTE	BEVESTIGING	ARTIKEL NR.	SNELCODE
Knop	mat wit	22x63mm	29mm	M4	VIE0590-63-MW	59001
Knop	mat zwart	22x63mm	29mm	M4	VIE0590-63-MZ	59002

ARTIKEL	UITVOERING	BOORAFSTAND	OVERMETEN	HOOGTE	BEVESTIGING	ARTIKEL NR.	SNELCODE
Greep	mat wit	160mm	222mm	28mm	M4	VIE0590-160-MW	59007
Greep	mat zwart	160mm	222mm	28mm	M4	VIE0590-160-MZ	59008

Technische Fiche



F

LUV knop & greep zamak

ARTIKEL	UITVOERING	BREEDTE X LENGTE	HOOGTE	BEVESTIGING	ARTIKEL NR.	SNELCODE
Knop	mat wit	17x51mm	31mm	M4	VIE0536-17-WI	53603
Knop	mat zwart	17x51mm	31mm	M4	VIE0536-17-ZW	53604
ARTIKEL	UITVOERING	BOORAFSTAND	OVERMETEN	BEVESTIGING	ARTIKEL NR.	SNELCODE
Greep	mat wit	192mm	202mm	M4	VIE0536-192-WI	53607
Greep	mat wit	320mm	330mm	M4	VIE0536-320-WI	53611
Greep	mat zwart	192mm	202mm	M4	VIE0536-192-ZW	53608
Greep	mat zwart	320mm	330mm	M4	VIE0536-320-ZW	53612

Technische Fiche



VALLEY greep

UITVOERING	BOORAFSTAND	OVERMETEN	OVERMETEN	BEVESTIGING	ARTIKEL NR.	SNELCODE
Zwart glans	160mm	223mm	25mm	M4	VIE0602-160-ZG	60203
Zwart glans	256mm	330mm	25mm	M4	VIE0602-256-ZG	60207
Zwart mat	160mm	223mm	25mm	M4	VIE0602-160-ZM	60204
Zwart mat	256mm	330mm	25mm	M4	VIE0602-256-ZM	60208

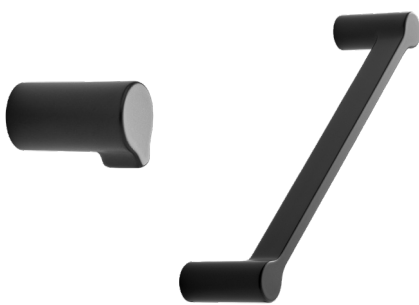

SCOPE knop & greep

UITVOERING	BOORAFSTAND	OVERMETEN	HOOGTE	DIAMETER	BEVESTIGING	ARTIKEL NR.	SNELCODE
Knop	/	20mm	30mm	16mm	M4 vijs	0706FP543KN-ZW	05034
Greep	160mm	176mm	36mm	16mm	M4 vijs	0706FP543GR-ZW	07034

Technische Fiche



QUART BIG knop & greep

KNOP	UITVOERING	AFMETINGEN	HOOGTE	BEVESTIGING	ARTIKEL NR.	SNELCODE
Knop	mat zwart	34x34mm	31mm	M4	VIE0616-34-ZW	61603
GREEP	UITVOERING	BOORAFSTAND	OVERMETEN	HOOGTE	ARTIKEL NR.	SNELCODE
Greep	mat zwart	160mm	184mm	35mm	VIE0616-160-ZW	61606

Technische Fiche



QUART MINI knop & greep

KNOP	UITVOERING	AFMETINGEN	HOOGTE	BEVESTIGING	ARTIKEL NR.	SNELCODE
Knop	mat zwart	26x26mm	24mm	M4	VIE0608-26-ZW	60803
GREEP	UITVOERING	BOORAFSTAND	OVERMETEN	HOOGTE	ARTIKEL NR.	SNELCODE
Greep	mat zwart	128mm	146mm	31mm	VIE0608-128-ZW	60806

Technische Fiche

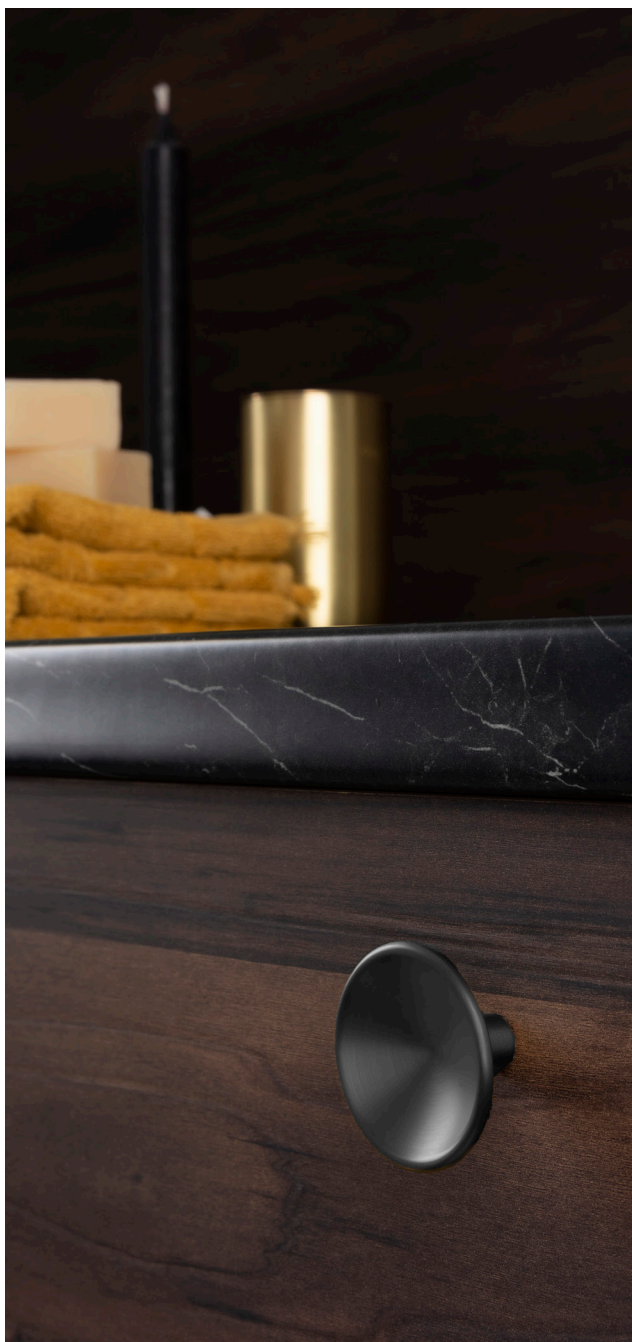

DISC knop zamak

UITVOERING	DIAMETER	HOOGTE	BEVESTIGING	ARTIKEL NR.	SNELCODE
Mat wit	38mm	21mm	M4	VIE0530-38-WI	53003
Mat wit	50mm	27mm	M4	VIE0530-50-WI	53007
Mat zwart	38mm	21mm	M4	VIE0530-38-ZW	53004
Mat zwart	50mm	27mm	M4	VIE0530-50-ZW	53008

Technische Fiche

**Oh!** knop zamak

UITVOERING	DIAMETER	HOOGTE	BEVESTIGING	ARTIKEL NR.	SNELCODE
Mat zwart	40mm	26mm	M4	VIE0601-40-ZW	60106

Technische Fiche

**PURA** greep zamak

UITVOERING	BOORAFSTAND	OVERMETEN	HOOGTE	BEVESTIGING	ARTIKEL NR.	SNELCODE
Zwart glans	160mm	168mm	28mm	M4	VIE0487-160-ZW	48703

Technische Fiche

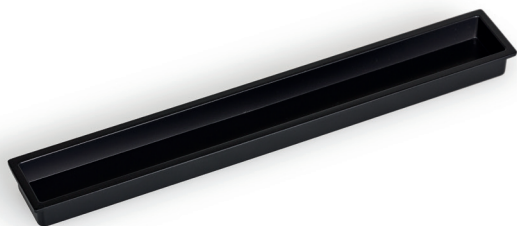

CUBIC infreesgreep

UITVOERING	FREESMAAT LENGTE	OVERMETEN	BOORMATEN	OVERMETEN BREEDTE	ARTIKEL NR.	SNELCODE
Mat wit	157mm	160mm	scan QR-code	24mm	VIE0366-160-WI	36601
Mat zwart	157mm	160mm	scan QR-code	24mm	VIE0366-160-ZW	36602

Technische Fiche



HEXXA greep - lengte inkortbaar!

UITVOERING	LENGTE	EINKAPPEN	AFMETINGEN	BEVESTIGING	ARTIKEL NR.	SNELCODE
Mat wit	200mm	inbegrepen	scan QR-code	infrezen	VIE0449-0200-W	44901
Mat wit	350mm	inbegrepen	scan QR-code	infrezen	VIE0449-0350-W	44905
Mat wit	1100mm	inbegrepen	scan QR-code	infrezen	VIE0449-1100-W	44909
Mat wit	3000mm	zonder eindkap	scan QR-code	infrezen	VIE0449-3000-W	44913
Mat zwart	200mm	inbegrepen	scan QR-code	infrezen	VIE0449-0200-Z	44902
Mat zwart	350mm	inbegrepen	scan QR-code	infrezen	VIE0449-0350-Z	44906
Mat zwart	1100mm	inbegrepen	scan QR-code	infrezen	VIE0449-1100-Z	44910
Mat zwart	3000mm	zonder eindkap	scan QR-code	infrezen	VIE0449-3000-Z	44914

HEXXA eindkap

Mat wit	eindkap links	voor afmetingen scan QR-code	VIE0449-035-WL	44917
Mat wit	eindkap rechts	voor afmetingen scan QR-code	VIE0449-035-WR	44918
Mat zwart	eindkap links	voor afmetingen scan QR-code	VIE0449-035-ZL	44919
Mat zwart	eindkap rechts	voor afmetingen scan QR-code	VIE0449-035-ZR	44920

Technische Fiche



EQUIS knop

UITVOERING	DIAMETER	HOOGTE	BEVESTIGING	ARTIKEL NR.	SNELCODE
Mat wit	40x40mm	25mm	M4	VIE0614-40-MW	61402
Mat zwart	40x40mm	25mm	M4	VIE0614-40-MZ	61401
Glans zwart	40x40mm	25mm	M4	VIE0614-40-ZN	61404

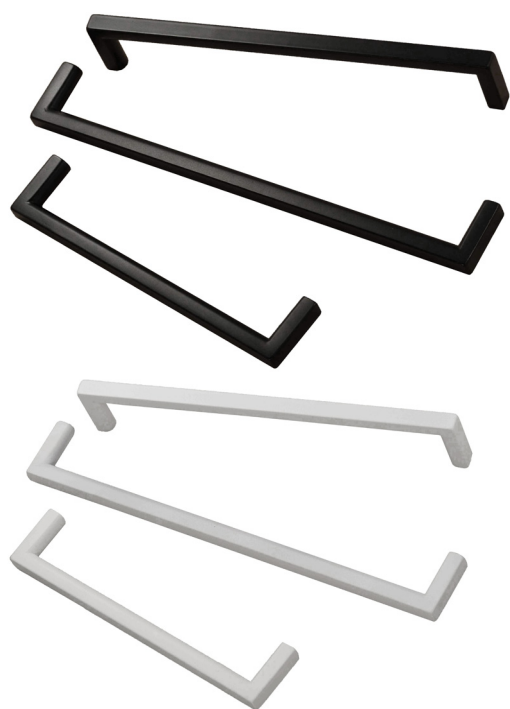

F

VERSTEEKGREEP wit & zwart

UITVOERING	BOORAFSTAND	OVERMETEN	HOOGTE	DIAMETER	BEVESTIGING	ARTIKEL NR.	SNELCODE
Zwart	128mm	136mm	28mm	8mm	M4 vijs	0706V6765.032	20112
Zwart	160mm	168mm	28mm	8mm	M4 vijs	0706V6764.032	20212
Zwart	192mm	200mm	28mm	8mm	M4 vijs	0706V6763.032	20312
Zwart	320mm	328mm	28mm	8mm	M4 vijs	0706V6761.032	20412
Wit	128mm	136mm	28mm	8mm	M4 vijs	0706V6765.292	20512
Wit	160mm	168mm	28mm	8mm	M4 vijs	0706V6764.292	20612
Wit	192mm	200mm	28mm	8mm	M4 vijs	0706V6763.292	20712
Wit	320mm	328mm	28mm	8mm	M4 vijs	0706V6761.292	20812



SENSE greep geborsteld zwart

BOORAFSTAND	LENGTE	HOOGTE	BEVESTIGING	ARTIKEL NR.	SNELCODE
128mm	135mm	30mm	M4 vijs	VIE0195-128-ZW	19501
192mm	199mm	30mm	M4 vijs	VIE0195-192-ZW	19502
320mm	327mm	30mm	M4 vijs	VIE0195-320-ZW	19503
480mm	487mm	30mm	M4 vijs	VIE0195-480-ZW	19504

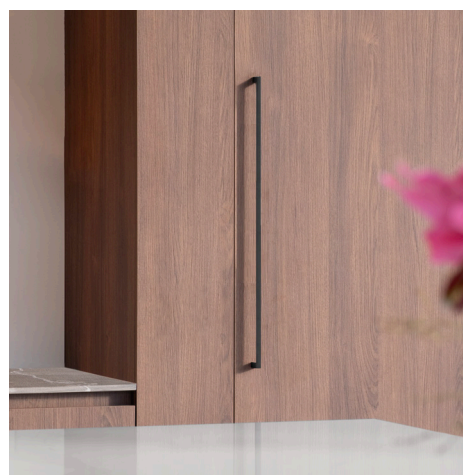

THIN greep mat zwart gelakt

BOORAFSTAND	OVERMETEN	HOOGTE	DIAMETER	BEVESTIGING	ARTIKEL NR.	SNELCODE
96mm	104mm	28mm	9mm	M4 vijs	0706GR089413ZW	08031
128mm	136mm	28mm	9mm	M4 vijs	0706GR089414ZW	09031
160mm	168mm	28mm	9mm	M4 vijs	0706GR089415ZW	10031
192mm	200mm	28mm	9mm	M4 vijs	0706GR089416ZW	11031
320mm	328mm	28mm	9mm	M4 vijs	0706GR089420ZW	12031



Lounge greep

UITVOERING	BOORAFSTAND	OVERMETEN	HOOGTE	BEVESTIGING	ARTIKEL NR.	SNELCODE
Zwart	160mm	174mm	35mm	M4 vijs	0706FP240330-95	24034



ESTE greep

UITVOERING	BOORAFSTAND	OVERMETEN	HOOGTE	BEVESTIGING	ARTIKEL NR.	SNELCODE
Mat zwart	160mm	172mm	30mm	M4 vijs	VIE446-160-ZW	44603

F

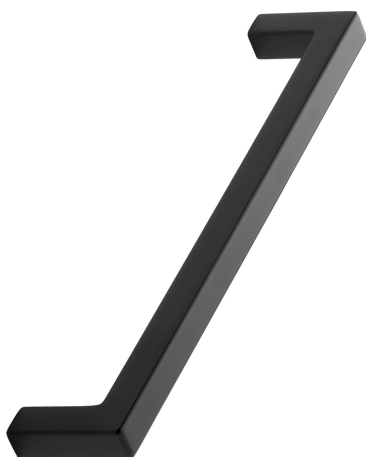

SQUARE greep 10 x 10mm zamak

UITVOERING	BOORAFSTAND	OVERMETEN	HOOGTE	BEVESTIGING	ARTIKEL NR.	SNELCODE
Mat zwart	128mm	138mm	32mm	M4 vijs	0706FP51036-128-ZW	51036
Mat zwart	160mm	170mm	32mm	M4 vijs	0706FP51036-160-ZW	51037
Mat zwart	224mm	234mm	32mm	M4 vijs	0706FP51036-224-ZW	51038
Mat zwart	320mm	330mm	32mm	M4 vijs	0706FP51036-320-ZW	51039
Mat zwart	448mm	458mm	32mm	M4 vijs	0706FP51036-448-ZW	51040

SQUARE greep 10 x 10mm alu

UITVOERING	BOORAFSTAND	OVERMETEN	HOOGTE	BEVESTIGING	ARTIKEL NR.	SNELCODE
Geborsteld zwart	128mm	138mm	32mm	M4 vijs	0706FP4350128ZW	04065

SQUARE greep 10 x 10mm oceanix

UITVOERING	BOORAFSTAND	OVERMETEN	HOOGTE	BEVESTIGING	ARTIKEL NR.	SNELCODE
Zwart	128mm	138mm	32mm	Houtvijzen (inbegrepen)	0706FP70002-128-ZW	70002

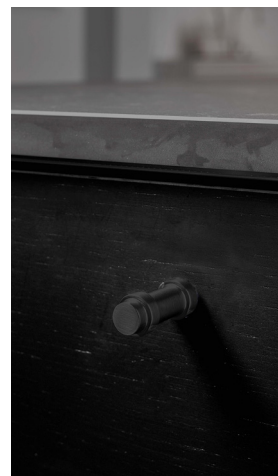

PILLAR knop & greep mat zwart

ARTIKEL	BOORAFSTAND	OVERMETEN	HOOGTE	BEVESTIGING	ARTIKEL NR.	SNELCODE
Knop	/	15mm	33mm	M4 vijs	0706FP547772-99	54773
Greep	160mm	175mm	33mm	M4 vijs	0706FP547620.99	54763

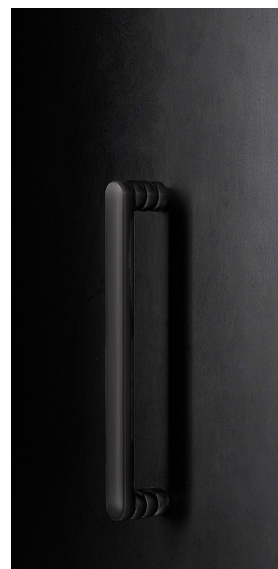
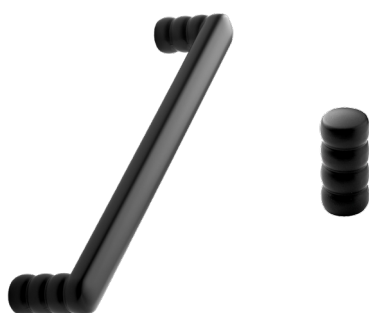

BOUNCE knop & greep mat zwart

ARTIKEL	UITVOERING	BOORAFSTAND	OVERMETEN	HOOGTE	BEVESTIGING	ARTIKEL NR.	SNELCODE
Knop	mat zwart	/	16mm	34mm	M4 vijs	0706FP54676.99	54677
Greep	mat zwart	160mm	176mm	33mm	M4 vijs	0706FP54666.99	54660

Technische Fiche



PEAK greep

KLEUR	UITVOERING	BOORAFSTAND	OVERMETEN	ARTIKEL NR.	SNELCODE
Mat wit	greep midden	160/192 mm	250mm	VIE444-250-WIT	44401
Mat wit	greep midden	160/448 mm	500mm	VIE444-500-WIT	44402
Mat wit	greep midden	160/768 mm	800mm	VIE444-800-WIT	44403
Mat wit	greep boven	160/1120 mm	1150mm	VIE444-1150-WIT	44404
Mat wit	greep midden	160/1760 mm	1800mm	VIE444-1800-WIT	44405
Zwart	greep midden	160/192 mm	250mm	VIE444-250-ZW	44406
Zwart	greep midden	160/448 mm	500mm	VIE444-500-ZW	44407
Zwart	greep midden	160/768 mm	800mm	VIE444-800-ZW	44408
Zwart	greep boven	160/1120 mm	1150mm	VIE444-1150-ZW	44409
Zwart	greep midden	160/1760 mm	1800mm	VIE444-1800-ZW	44410

Technische Fiche

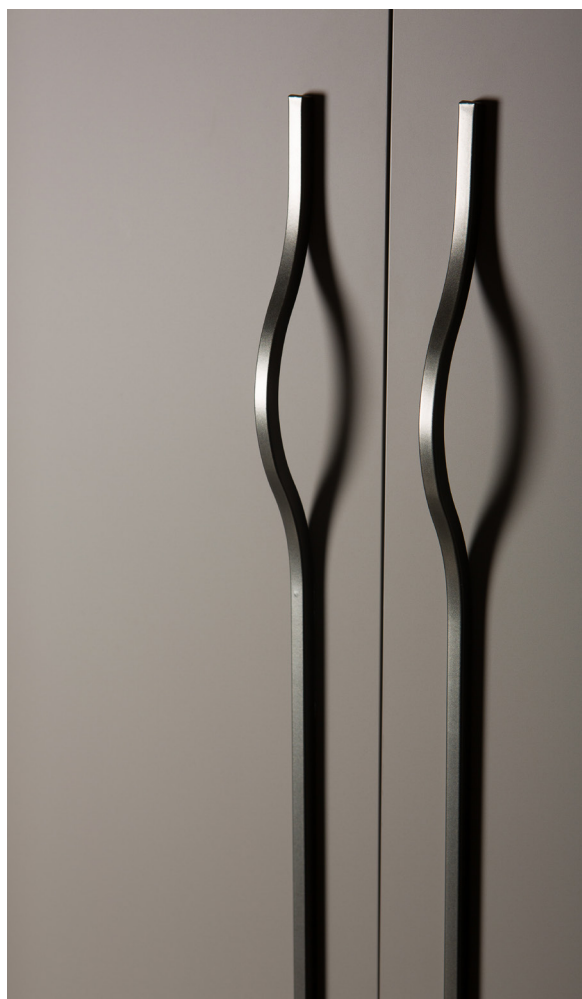
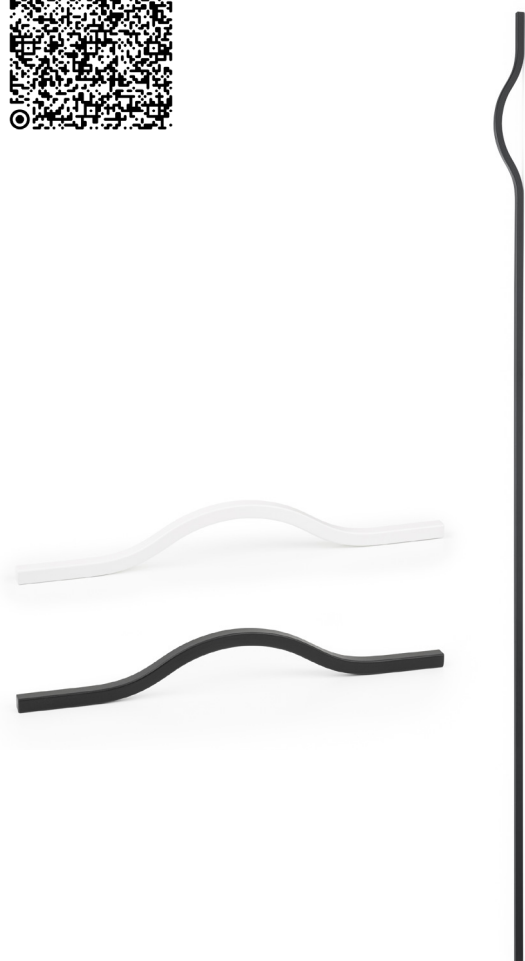

F

BRAVE greep

KLEUR	UITVOERING	BOORAFSTAND	OVERMETEN	ARTIKEL NR.	SNELCODE
Mat wit	greep midden	128mm	160mm	VIE452-160-WIT	45201
Mat wit	greep midden	192mm	240mm	VIE452-240-WIT	45202
Mat wit	greep midden	320mm	400mm	VIE452-400-WIT	45203
Mat wit	greep midden	192/480 mm	600mm	VIE452-600-WIT	45204
Mat wit	greep bovenaan	192/992 mm	1040mm	VIE452-1040-WIT	45205
Mat wit	greep midden	192/1120 mm	1150mm	VIE452-1150-WIT	45206
Mat zwart	greep midden	128mm	160mm	VIE452-160-ZW	45207
Mat zwart	greep midden	192mm	240mm	VIE452-240-ZW	45208
Mat zwart	greep midden	320mm	400mm	VIE452-400-ZW	45209
Mat zwart	greep midden	192/480 mm	600mm	VIE452-600-ZW	45210
Mat zwart	greep bovenaan	192/992 mm	1040mm	VIE452-1040-ZW	45211
Mat zwart	greep midden	192/1120 mm	1150mm	VIE452-1150-ZW	45212

Technische Fiche



ONA greep

UITVOERING	BOORAFSTAND	OVERMETEN	BEVESTIGING	ARTIKEL NR.	SNELCODE
Mat wit	32mm	50mm	M4	VIE0372-50-WI	37201
Mat wit	128mm	200mm	M4	VIE0372-200-WI	37202
Mat wit	256mm	350mm	M4	VIE0372-350-WI	37203
Mat wit	544mm	600mm	M4	VIE0372-600-WI	37204
Mat wit	416/1056 mm	1100mm	M4	VIE0372-1100-WI	37205
Mat wit	480/1440 mm	1500mm	M4	VIE0372-1500-WI	37206
Geborsteld zwart	32mm	50mm	M4	VIE0372-50-ZW	37207
Geborsteld zwart	128mm	200mm	M4	VIE0372-200-ZW	37208
Geborsteld zwart	256mm	350mm	M4	VIE0372-350-ZW	37209
Geborsteld zwart	544mm	600mm	M4	VIE0372-600-ZW	37210
Geborsteld zwart	416/1056 mm	1100mm	M4	VIE0372-1100-ZW	37211
Geborsteld zwart	480/1440 mm	1500mm	M4	VIE0372-1500-ZW	37212

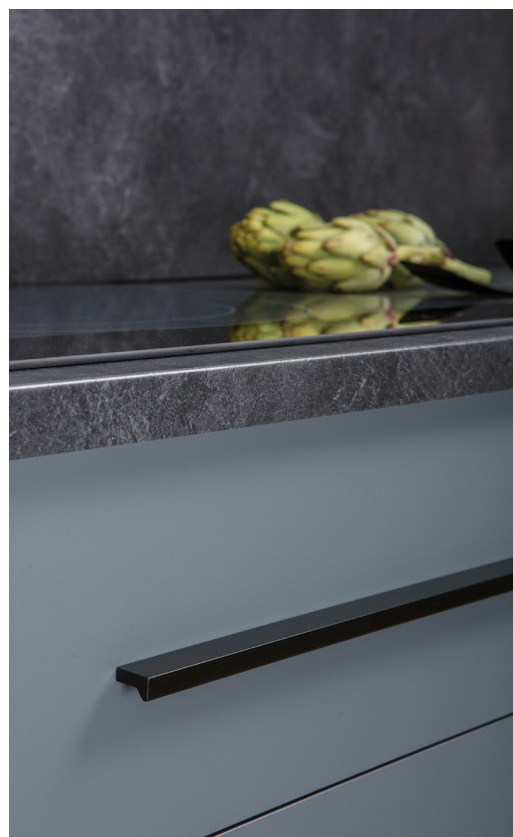

ANGLE greep

UITVOERING	BOORAFSTAND	OVERMETEN	HOOGTE	BEVESTIGING	ARTIKEL NR.	SNELCODE
Mat wit	64mm	100mm	11mm	M4	VIE0077-100-WIT	77008
Mat wit	128mm	200mm	11mm	M4	VIE0077-200-WIT	77009
Mat wit	192mm	300mm	11mm	M4	VIE0077-300-WIT	77010
Mat wit	256mm	400mm	11mm	M4	VIE0077-400-WIT	77011
Mat wit	416mm	500mm	11mm	M4	VIE0077-500-WIT	77012
Mat wit	480mm	600mm	11mm	M4	VIE0077-600-WIT	77013
Mat wit	640mm	900mm	11mm	M4	VIE0077-900-WIT	77014
Mat wit	1440mm	1480mm	11mm	M4	VIE0077-1440-WIT	77023
Mat zwart	64mm	100mm	11mm	M4	VIE0077-100-ZW	77015
Mat zwart	128mm	200mm	11mm	M4	VIE0077-200-ZW	77016
Mat zwart	192mm	300mm	11mm	M4	VIE0077-300-ZW	77017
Mat zwart	256mm	400mm	11mm	M4	VIE0077-400-ZW	77018
Mat zwart	416mm	500mm	11mm	M4	VIE0077-500-ZW	77019
Mat zwart	480mm	600mm	11mm	M4	VIE0077-600-ZW	77020
Mat zwart	640mm	900mm	11mm	M4	VIE0077-900-ZW	77021
Mat zwart	1440mm	1480mm	11mm	M4	VIE0077-1440-ZW	77022

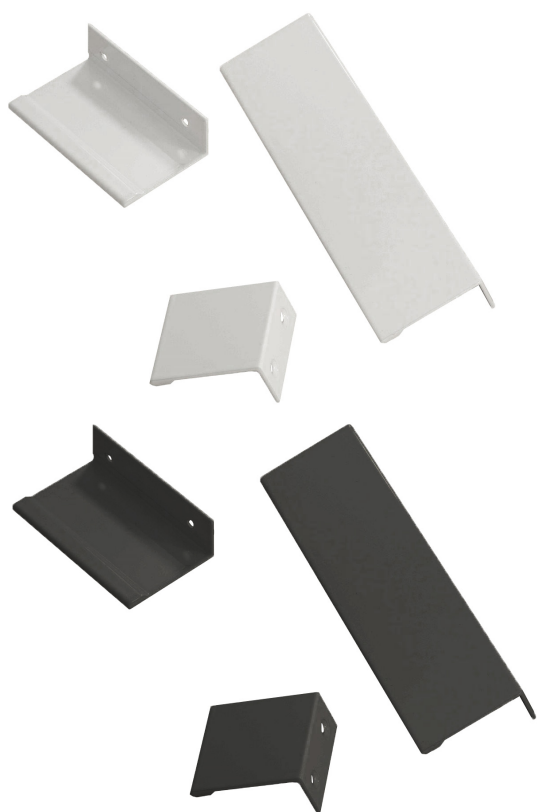

L-GREEP gelakt

UITVOERING	OVERMETEN	DIKTE	AANTAL BORINGEN	BEVESTIGING	ARTIKEL NR.	SNELCODE
Wit gelakt mat	40mm	1.5mm	2	Houtvijs	SGK.35159	10064
Wit gelakt mat	70mm	1.5mm	2	Houtvijs	SGK.35160	11064
Wit gelakt mat	150mm	1.5mm	3	Houtvijs	SGK.35161	12064
Wit gelakt mat	300mm	1.5mm	3	Houtvijs	SGK.35162	13064
Wit gelakt mat	500mm	1.5mm	3	Houtvijs	SGK.35163	14064
Wit gelakt mat	1000mm	1.5mm	4	Houtvijs	SGK.35201	35201
Zwart gelakt mat	40mm	1.5mm	2	Houtvijs	SGK.35164	15064
Zwart gelakt mat	70mm	1.5mm	2	Houtvijs	SGK.35165	16064
Zwart gelakt mat	150mm	1.5mm	3	Houtvijs	SGK.35166	17064
Zwart gelakt mat	300mm	1.5mm	3	Houtvijs	SGK.35167	18064
Zwart gelakt mat	500mm	1.5mm	3	Houtvijs	SGK.35168	19064
Zwart gelakt mat	1000mm	1.5mm	4	Houtvijs	SGK.35202	35202

Zwarte houtvijzen 3.0x16 - zie pagina N 2

Technische Fiche

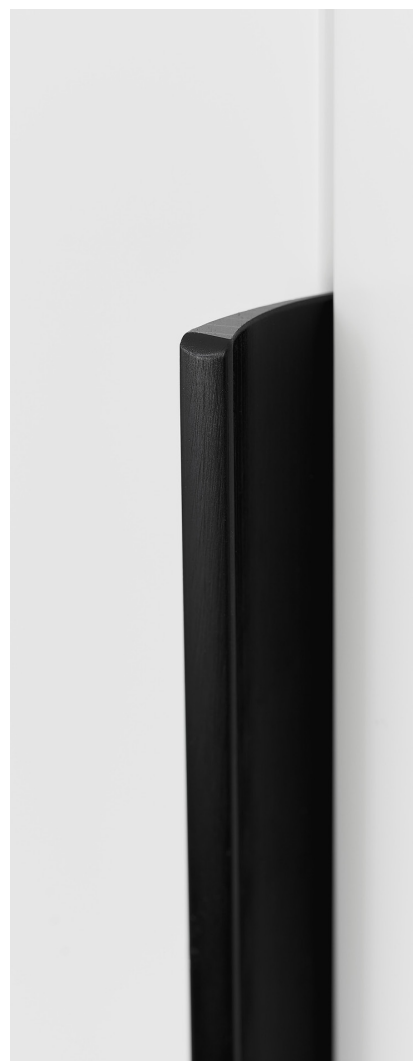

F

EDGE STRAIGHT greep

UITVOERING	OVERMETEN	BOORAFSTAND	BOORGATEN	BREEDTE	BEVESTIGING	ARTIKEL NR.	SNELCODE
Wit	40mm	20mm	2	41mm	M4	0706FP41972-40W	13062
Wit	100mm	60mm	2	41mm	M4	0706FP41972100W	41973
Wit	200mm	80mm	3	41mm	M4	0706FP41972200W	20062
Wit	350mm	160mm	3	41mm	M4	0706FP41972350W	27062

UITVOERING	OVERMETEN	BOORAFSTAND	BOORGATEN	BREEDTE	BEVESTIGING	ARTIKEL NR.	SNELCODE
Zwart mat	40mm	20mm	2	41mm	M4	0706FP41972-40Z	30062
Zwart mat	100mm	60mm	2	41mm	M4	0706FP41972100Z	41972
Zwart mat	200mm	80mm	3	41mm	M4	0706FP41972200Z	31062
Zwart mat	350mm	160mm	3	41mm	M4	0706FP41972350Z	32062
Zwart mat	600mm	160mm	4	41mm	M4	0706FP41972600Z	32603
Zwart mat	1200mm	160mm	7	41mm	M4	0706FP41972912Z	32103

NIEUW!



OPZETGREEP TRIM mat zwart

LENGTE	FRONTMAAT	BREEDTE	HOOGTE	BEVESTIGING	ARTIKEL NR.	SNELCODE
295mm	300mm	10/13mm	20/38mm	Infrezen	0706FP40829576	40871
395mm	400mm	10/13mm	20/38mm	Infrezen	0706FP40839576	40873
445mm	450mm	10/13mm	20/38mm	Infrezen	0706FP40844576	40874
495mm	500mm	10/13mm	20/38mm	Infrezen	0706FP40849576	40875
595mm	600mm	10/13mm	20/38mm	Infrezen	0706FP40859576	40876
795mm	800mm	10/13mm	20/38mm	Infrezen	0706FP40879576	40877
895mm	900mm	10/13mm	20/38mm	Infrezen	0706FP40889576	40878
995mm	1000mm	10/13mm	20/38mm	Infrezen	0706FP40899576	40879
1195mm	1200mm	10/13mm	20/38mm	Infrezen	0706FP408119576	40880

Technische Fiche



HIDE infreesgreep

UITVOERING	OVERMETEN	BOORAFSTAND	BEVESTIGING	ARTIKEL NR.	SNELCODE
Mat wit	180mm	128mm	Infrezen	VIE0094-180-WI	09401
Mat zwart	180mm	128mm	Infrezen	VIE0094-180-ZW	09402

F

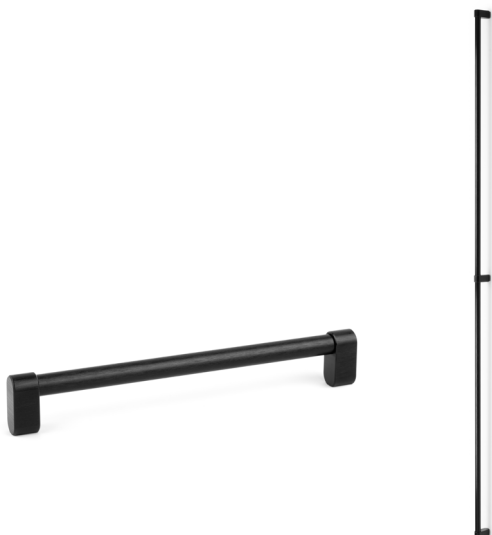

LINKK greep aluminium

UITVOERING	BOORAFSTAND	OVERMETEN	HOOGTE	BEVESTIGING	ARTIKEL NR.	SNELCODE
Zwart	160mm	175mm	37mm	M4	VIE0643160-ZW	64303
Zwart	320mm	335mm	37mm	M4	VIE0643320-ZW	64306
Zwart	528/ 1056mm	1071mm	37mm	M4	VIE06431056-ZW	64309

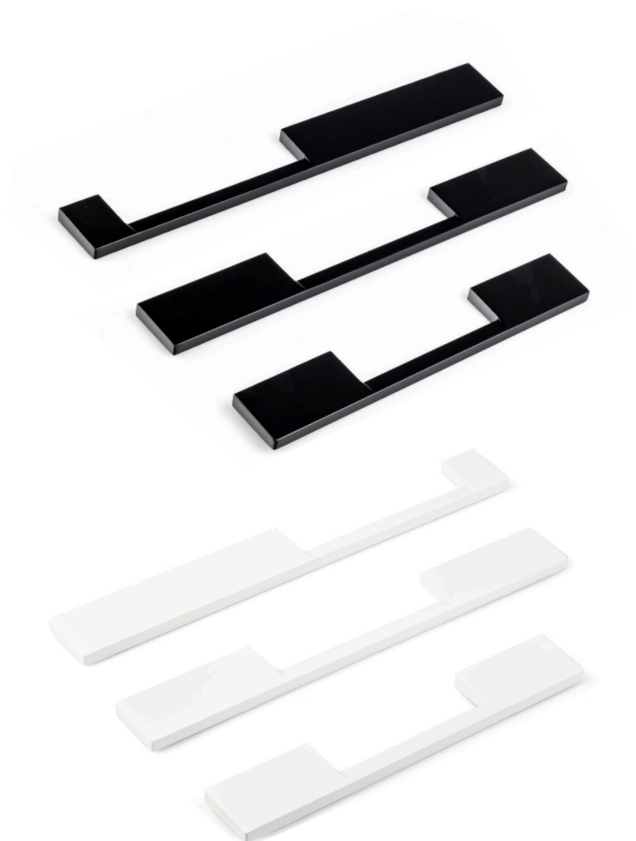

SPAZIO greep wit

UITVOERING	BOORAFSTAND	OVERMETEN	HOOGTE	BEVESTIGING	ARTIKEL NR.	SNELCODE
Gecentreerd	128mm	200mm	32mm	M4 vijs	0706V7572.292	20314
Gecentreerd	192mm	260mm	32mm	M4 vijs	0706V7571.292	20414
Uit het midden	192mm	260mm	32mm	M4 vijs	0706V7570.292	20215

SPAZIO greep zwart

UITVOERING	BOORAFSTAND	OVERMETEN	HOOGTE	BEVESTIGING	ARTIKEL NR.	SNELCODE
Gecentreerd	128mm	200mm	32mm	M4 vijs	0706V7572.032	20114
Gecentreerd	192mm	260mm	32mm	M4 vijs	0706V7571.032	20214
Uit het midden	192mm	260mm	32mm	M4 vijs	0706V7570.032	20115

Technische Fiche



VANN greep

UITVOERING	BOORAFSTAND	OVEREMTEN	BEVESTIGING	ARTIKEL NR.	SNELCODE
Mat zwart	64mm	100mm	M4	VIE0375-100-ZW	37505
Mat zwart	128mm	200mm	M4	VIE0375-200-ZW	37506
Mat zwart	256mm	350mm	M4	VIE0375-350-ZW	37507
Mat zwart	384/1120mm	1200mm	M4	VIE0375-1200-ZW	37508



NOBB knop & greep aluminium

UITVOERING	BOORAFSTAND	OVERMETEN	HOOGTE	BEVESTIGING	ARTIKEL NR.	SNELCODE
Zwart	/	52mm	45mm	M4	VIE0657-0052-ZW	65702
Zwart	192mm	244mm	45mm	M4	VIE0657-0192-ZW	65705
Zwart	320mm	372mm	45mm	M4	VIE0657-0320-ZW	65708
Zwart	528/1056mm	1108mm	45mm	M4	VIE0657-1056-ZW	65711

F

BLACK AND WHITE COLLECTION

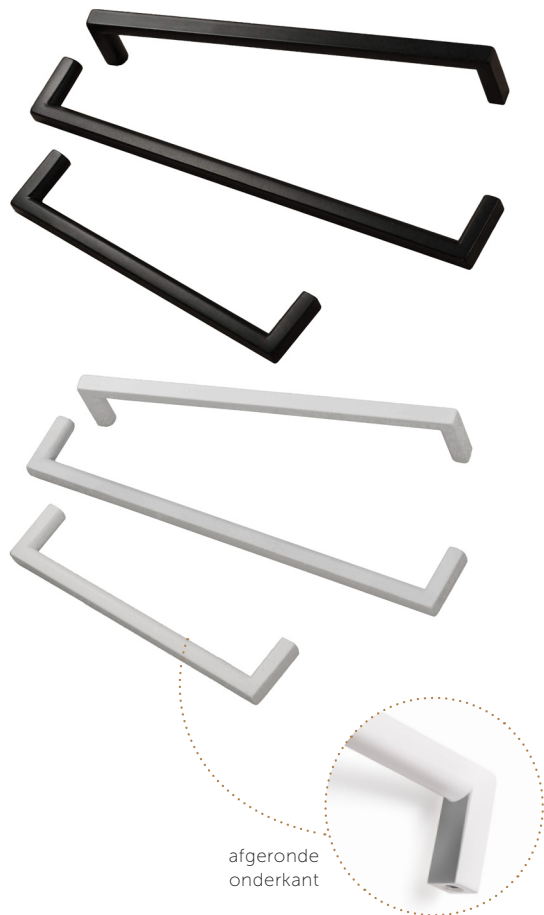

PROJECT GREEP wit & zwart

UITVOERING	BOORAFSTAND	OVERMETEN	HOOGTE	DIAMETER	BEVESTIGING	ARTIKEL NR.	SNELCODE
Zwart	128mm	136mm	28mm	8mm	M4 vijs	0706GR8583260128	85832
Zwart	160mm	168mm	28mm	8mm	M4 vijs	0706GR8583260160	85834
Zwart	192mm	200mm	28mm	8mm	M4 vijs	0706GR8583260192	85836
Zwart	320mm	328mm	28mm	8mm	M4 vijs	0706GR8583260320	85838
Wit	128mm	136mm	28mm	8mm	M4 vijs	0706GR8583200128	85831
Wit	160mm	168mm	28mm	8mm	M4 vijs	0706GR8583200160	85833
Wit	192mm	200mm	28mm	8mm	M4 vijs	0706GR8583200192	85835
Wit	320mm	328mm	28mm	8mm	M4 vijs	0706GR8583200320	85837



FRAME greep

UITVOERING	BOORAFSTAND	OVERMETEN	HOOGTE	DIAMETER	BEVESTIGING	ARTIKEL NR.	SNELCODE
Zwart	160mm	178mm	34mm	12mm	M4 vijs	0706FP517760ZW	11036



REGULAR 2 greep

UITVOERING	BOORAFSTAND	OVERMETEN	HOOGTE	DIAMETER	BEVESTIGING	ARTIKEL NR.	SNELCODE
Zwart	192mm	206mm	40mm	13mm	M4 vijs	0706FP240192-ZW	04044

F



HARLEQUIN knop

UITVOERING	OVERMETEN	HOOGTE	BEVESTIGING	ARTIKEL NR.	SNELCODE
Zwart	17mm	33mm	M4 vijs	0706FP240717-ZW	06044



PYRAMID greep

UITVOERING	BOORAFSTAND	OVERMETEN	HOOGTE	BEVESTIGING	ARTIKEL NR.	SNELCODE
Zwart	160mm	173mm	30mm	M4 vijs	0706ZW518760160	20221
Zwart	320mm	333mm	30mm	M4 vijs	0706ZW518760320	20121



RIO greep

UITVOERING	BOORAFSTAND	OVERMETEN	HOOGTE	BREEDTE	BEVESTIGING	ARTIKEL NR.	SNELCODE
Zwart	128mm	164mm	30mm	16mm	M4 vijs	0706ZW530660128	20122

F



CUBICO greep

UITVOERING	BOORAFSTAND	OVERMETEN	BREEDTE	BEVESTIGING	ARTIKEL NR.	SNELCODE
Zwart	192mm	201mm	15mm	M4 vijs	0706ZW518660192	20323



FLAT greep

UITVOERING	BOORAFSTAND	OVERMETEN	HOOGTE	DIAMETER	BEVESTIGING	ARTIKEL NR.	SNELCODE
Wit RAL9010	128mm	143mm	34mm	8mm	M4 vijs	0706W512860128	37355
Zwart RAL9005	128mm	143mm	34mm	8mm	M4 vijs	0706FP51286-128Z	51128
Zwart RAL9005	192mm	207mm	34mm	8mm	M4 vijs	0706FP51286-192Z	51192
Zwart RAL9005	256mm	271mm	34mm	8mm	M4 vijs	0706FP51286-256Z	51256
Zwart RAL9005	448mm	463mm	34mm	8mm	M4 vijs	0706FP51286-448Z	51448



MATIC greep

UITVOERING	BOORAFSTAND	OVERMETEN	DIAMETER	BEVESTIGING	ARTIKEL NR.	SNELCODE
Wit	96mm	126mm	13mm	M4 vijs	0706V7032.292	20313
Wit	128mm	160mm	14mm	M4 vijs	0706V7031.292	20413
Zwart	96mm	126mm	13mm	M4 vijs	0706V7032.032	20113
Zwart	128mm	160mm	14mm	M4 vijs	0706V7031.032	20213



SLIM greep

UITVOERING	BOORAFSTAND	OVERMETEN	BEVESTIGING	ARTIKEL NR.	SNELCODE
Zwart	160mm	200mm	M4 vijs	0706ZW515460160	20123
Zwart	320mm	360mm	M4 vijs	0706ZW515460320	20223
Zwart	448mm	488mm	M4 vijs	0706ZW515460448	20225

F

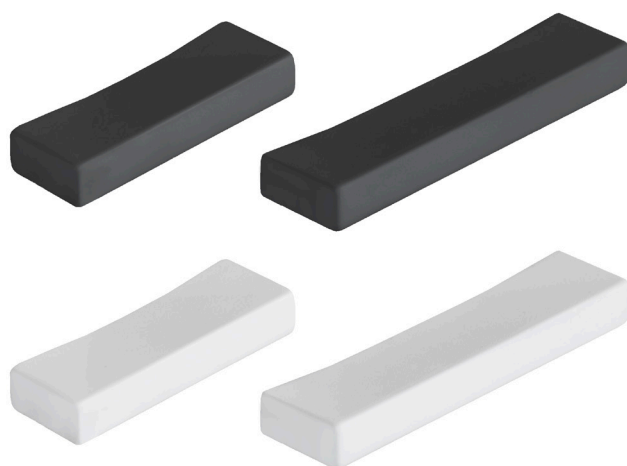

BLOK greep

UITVOERING	BOORAFSTAND	LENGTE X DIKTE	HOOGTE	BEVESTIGING	ARTIKEL NR.	SNELCODE
Wit	32mm	55x10mm	18mm	M4 vijs	0706V7483.292	20416
Wit	64mm	85x11mm	18mm	M4 vijs	0706V7482.292	20516
Wit	96mm	115x12mm	18mm	M4 vijs	0706V7481.292	20616
Zwart	32mm	55x10mm	18mm	M4 vijs	0706V7483.032	20116
Zwart	64mm	85x11mm	18mm	M4 vijs	0706V7482.032	20216
Zwart	96mm	115x12mm	18mm	M4 vijs	0706V7481.032	20316



ROND knop

UITVOERING	DIAMETER	HOOGTE	BEVESTIGING	ARTIKEL NR.	SNELCODE
Wit	15mm	22mm	M4 vijs	0706V8162.292	20328
Wit	25mm	34mm	M4 vijs	0706V8161.292	20428
Zwart	15mm	22mm	M4 vijs	0706V8162.032	20128
Zwart	25mm	34mm	M4 vijs	0706V8161.032	20228



OVAAL knop

UITVOERING	AFMETINGEN	HOOGTE	BEVESTIGING	ARTIKEL NR.	SNELCODE
Wit	27x11mm	22mm	M4 vijs	0706V8172.292	20329
Wit	34x14mm	34mm	M4 vijs	0706V8171.292	20429
Zwart	27x11mm	22mm	M4 vijs	0706V8172.032	20129
Zwart	34x14mm	34mm	M4 vijs	0706V8171.032	20229

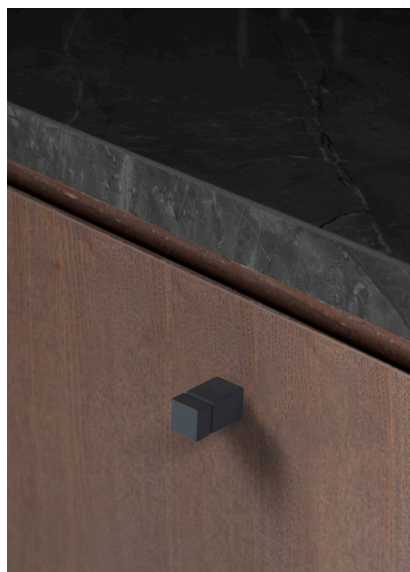
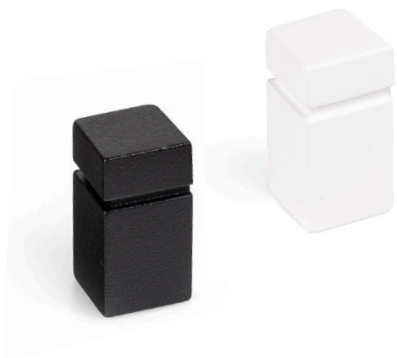

701 knop & greep

ARTIKEL	UITVOERING	AFMETINGEN	HOOGTE	BEVESTIGING	ARTIKEL NR.	SNELCODE	
Knop	wit	15x15mm	30mm	M4 vijs	Q701 15 65 01	20330	
Knop	wit	20x20mm	30mm	M4 vijs	Q701 20 65 01	20430	
Knop	zwart	15x15mm	30mm	M4 vijs	Q701 15 60 01	20130	
Knop	zwart	20x20mm	30mm	M4 vijs	Q701 20 60 01	20230	
ARTIKEL	UITVOERING	BOORAFSTAND	OVERMETEN	HOOGTE	BEVESTIGING	ARTIKEL NR.	SNELCODE
Greep	wit	96mm	111mm	30mm	M4 vijs	Q701 96 65 0196	20319
Greep	wit	128mm	144mm	30mm	M4 vijs	Q701 28 65 0128	20419
Greep	zwart	96mm	111mm	30mm	M4 vijs	Q701 96 60 0196	30119
Greep	zwart	128mm	144mm	30mm	M4 vijs	Q701 28 60 0128	20219



T-greep zwart

UITVOERING	BOORAFSTAND	OVERMETEN	HOOGTE	DIAMETER	BEVESTIGING	ARTIKEL NR.	SNELCODE
Zwart	128mm	188mm	32mm	12mm	M4 vijs	0706ZW8525-128	85128
Zwart	160mm	220mm	32mm	12mm	M4 vijs	0706ZW8525-160	85160
Zwart	192mm	252mm	32mm	12mm	M4 vijs	0706ZW8525-192	85192
Zwart	320mm	380mm	32mm	12mm	M4 vijs	0706ZW8525-320	85320



BEUGEL greep

UITVOERING	BOORAFSTAND	OVERMETEN	HOOGTE	DIAMETER	BEVESTIGING	ARTIKEL NR.	SNELCODE
Zwart	96mm	106mm	32mm	10mm	M4 vijs	0706ZW7213-096	72096
Zwart	128mm	138mm	32mm	10mm	M4 vijs	0706ZW7213-128	72128
Zwart	160mm	170mm	32mm	10mm	M4 vijs	0706ZW7213-160	72160
Zwart	192mm	202mm	32mm	10mm	M4 vijs	0706ZW7213-192	72192



BOW greep

UITVOERING	BOORAFSTAND	DIAMETER	BEVESTIGING	ARTIKEL NR.	SNELCODE
Zwart	96mm	10mm	M4 vijs	0706ZW7214-096	73096
Zwart	128mm	10mm	M4 vijs	0706ZW7214-128	73128
Zwart	160mm	10mm	M4 vijs	0706ZW7214-160	73160
Zwart	192mm	10mm	M4 vijs	0706ZW7214-192	73192
Zwart	320mm	10mm	M4 vijs	0706ZW7214-320	73320



Banaan greep

UITVOERING	BOORAFSTAND	DIAMETER	BEVESTIGING	ARTIKEL NR.	SNELCODE
Wit	96mm	9mm	M4 vijs	0706V7862 002	08007
Wit	128mm	10mm	M4 vijs	0706V7861 002	13007
Zwart	96mm	9mm	M4 vijs	0706V7862 033	09007
Zwart mat	128mm	10mm	M4 vijs	0706V7861 032	14007



COMO knop

UITVOERING	DIAMETER	HOOGTE	BEVESTIGING	ARTIKEL NR.	SNELCODE
Mat wit	26mm	18mm	M4 vijs	VIE0168-26-WIT	16805
Mat wit	41mm	25mm	M4 vijs	VIE0168-41-WIT	16811
Mat zwart	26mm	18mm	M4 vijs	VIE0168-26-ZWA	16806
Mat zwart	41mm	25mm	M4 vijs	VIE0168-41-ZWA	16812



DUKE knop

UITVOERING	DIAMETER	HOOGTE	BEVESTIGING	ARTIKEL NR.	SNELCODE
Mat wit	32mm	26mm	M4 vijs	VIE0393-31-WIT	39305
Mat zwart	32mm	26mm	M4 vijs	VIE0393-31-ZWA	39306

F

Technische Fiche

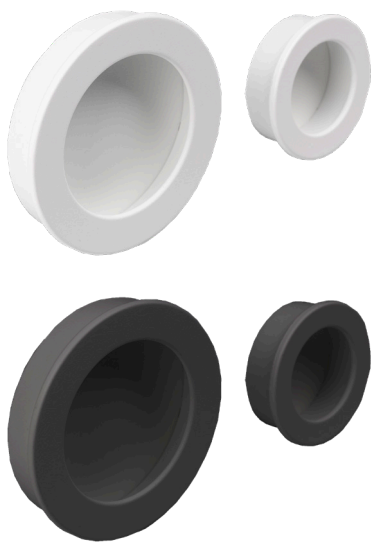

ROND infreesgreep

UITVOERING	OVERMETEN	DIEPTE	BEVESTIGING	ARTIKEL NR.	SNELCODE
Zwart	65mm	11mm	Infrezen	0706V3500.032	20106
Zwart	40mm	11mm	Infrezen	0706V3511.032	20206
Zwart	30mm	11mm	Infrezen	0706V3512.032	20306
Wit	65mm	11mm	Infrezen	0706V3500.292	20406
Wit	40mm	11mm	Infrezen	0706V3511.292	20506
Wit	30mm	11mm	Infrezen	0706V3512.292	20606



BOXX knop

UITVOERING	HOOGTE	AFMETINGEN	BEVESTIGING	ARTIKEL NR.	SNELCODE
Mat zwart	25mm	15x15mm	M4 vijs	VIE0097-15-ZWA	97001



KNOT knop

UITVOERING	BREEDTE	HOOGTE	BEVESTIGING	ARTIKEL NR.	SNELCODE
Zwart	75mm	44mm	M4 vijs	0706FP2380375ZW	08077

Technische Fiche

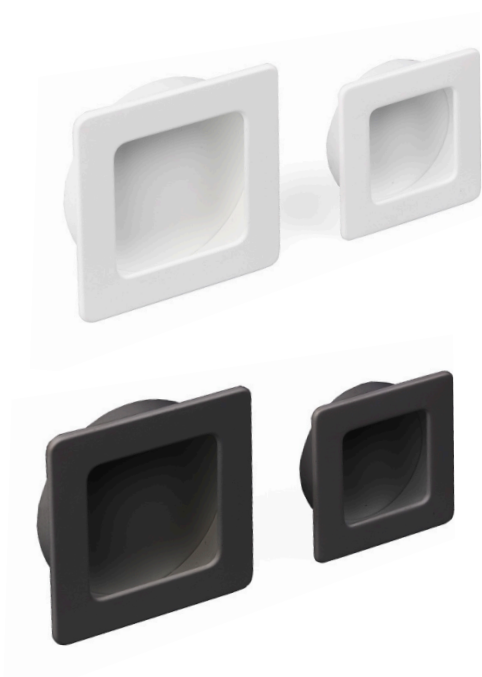

VIERKANT infreesgreep

UITVOERING	OVERMETEN	DIEPTE	BEVESTIGING	ARTIKEL NR.	SNELCODE
Zwart	64x64mm	11mm	Infrezen	0706V3600.032	20107
Zwart	50x50mm	11mm	Infrezen	0706V3560.032	20207
Zwart	39x39mm	11mm	Infrezen	0706V3561.032	20307
Zwart	29x29mm	11mm	Infrezen	0706V3562.032	20407
Wit	64x64mm	11mm	Infrezen	0706V3600.292	20507
Wit	50x50mm	11mm	Infrezen	0706V3560.292	20607
Wit	39x39mm	11mm	Infrezen	0706V3561.292	20707
Wit	29x29mm	11mm	Infrezen	0706V3562.292	20807

Technische Fiche

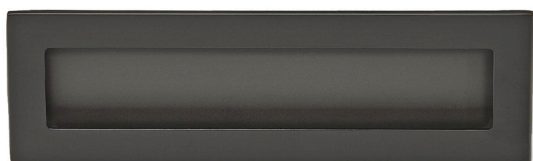

INN infreesgreep

UITVOERING	OVERMETEN	BEVESTIGING	ARTIKEL NR.	SNELCODE
Zwart	50x160mm	infrezen	0706ZW512160160	07054
Zwart	50x202mm	infrezen	0706ZW512160192	07059

NIEUW!

F

Technische Fiche

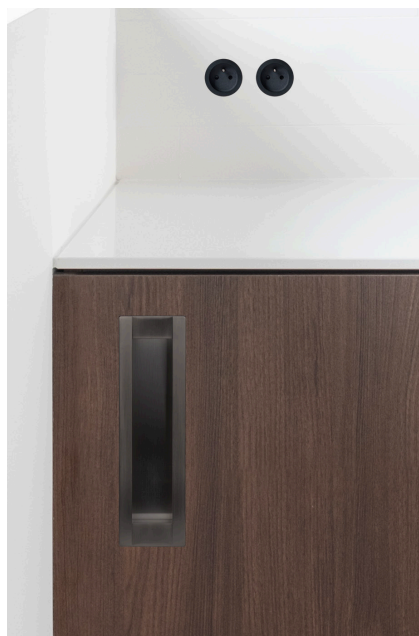

RECHTHOEK infreesgreep

UITVOERING	OVERMETEN	BOORAFSTAND	DIEPTE	BOORMAAT	BEVESTIGING	ARTIKEL NR.	SNELCODE
Wit	180x50mm	160mm	14mm	scan QR code	Infrezen	0706V3720.292	20209
Zwart	180x50mm	160mm	14mm	scan QR code	Infrezen	0706V3720.032	20109

Technische Fiche



SCHUIFDEUR infreesgreep

UITVOERING	OVERMETEN	BOORMAAT	BEVESTIGING	ARTIKEL NR.	SNELCODE
Wit	150x40mm	scan QR code	Infrezen	0706V3921.292	20308
Wit	110x36mm	scan QR code	Infrezen	0706V3922.292	20408
Zwart	150x40mm	scan QR code	Infrezen	0706V3921.032	20108
Zwart	110x36mm	scan QR code	Infrezen	0706V3922.032	20208

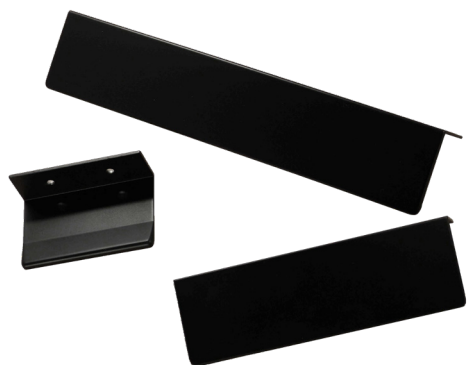

L-GREEP zamak

UITVOERING	BOORAFSTAND	OVERMETEN	BREEDTE	BEVESTIGING	ARTIKEL NR.	SNELCODE
Wit	32mm	71mm	45mm	Houtvijs	0706V7663.292	20417
Wit	96mm	135mm	45mm	Houtvijs	0706V7662.292	20517
Wit	192mm	231mm	45mm	Houtvijs	0706V7661.292	20617
Zwart	32mm	71mm	45mm	Houtvijs	0706V7663.032	20117
Zwart	96mm	135mm	45mm	Houtvijs	0706V7662.032	20217
Zwart	192mm	231mm	45mm	Houtvijs	0706V7661.032	20317

Zwarte houtvijsen 3.0x16 - zie pagina N 2

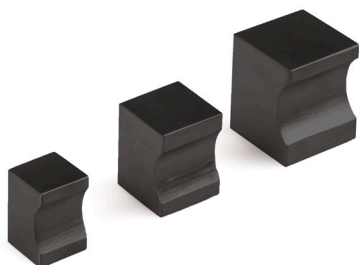

QUADRO knop

UITVOERING	DIAMETER	HOOGTE	BEVESTIGING	ARTIKEL NR.	SNELCODE
Mat zwart	15x15mm	22mm	M4 vijs	0706 FH319.15ZW	04068
Mat zwart	20x20mm	25mm	M4 vijs	0706 FH319.20ZW	05068
Mat zwart	25x25mm	30mm	M4 vijs	0706 FH319.25ZW	06068



RONDO knop

UITVOERING	DIAMETER	HOOGTE	BEVESTIGING	ARTIKEL NR.	SNELCODE
Mat zwart	15mm	22mm	M4 vijs	0706 FH302-15Z	21918
Mat zwart	20mm	24mm	M4 vijs	0706 FH302-20Z	21921
Mat zwart	25mm	26mm	M4 vijs	0706 FH302-25Z	21923

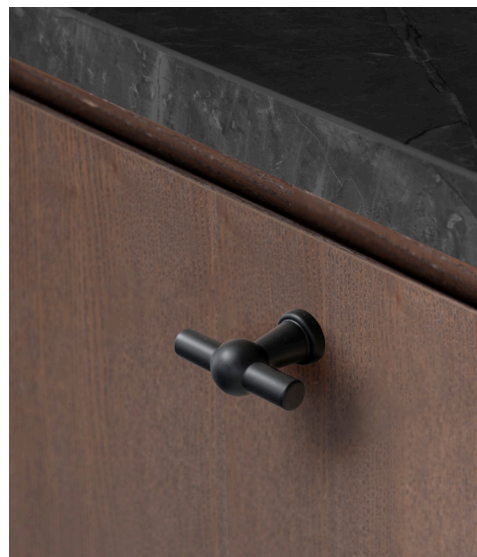

PETRA knop 46mm

UITVOERING	HOOGTE	BREEDTE	BEVESTIGING	ARTIKEL NR.	SNELCODECODE
Zwart	35mm	46mm	M4 vijs	HDD 2.129.090	21290



PETRA greep 96mm

UITVOERING	BOORAFSTAND	OVERMETEN	HOOGTE	BEVESTIGING	ARTIKEL NR.	SNELCODECODE
Zwart	96mm	120mm	35mm	M4 vijs	HDD 2.263.090	22630



ZEPPELIN knop

UITVOERING	DIAMETER	HOOGTE	BEVESTIGING	ARTIKEL NR.	SNELCODE
Zwart	53mm	38mm	M4 vijs	0706ZW530460053	20134



OLIJF knop

UITVOERING	DIAMETER	HOOGTE	BEVESTIGING	ARTIKEL NR.	SNELCODE
Zwart	36mm	32mm	M4 vijs	0730 599-36 ZWX	05112
Zwart	45mm	38mm	M4 vijs	0730 599-45 ZWX	10112
Zwart	54mm	44mm	M4 vijs	0730 599-54 ZWX	15112

F



OVAL SIMPLE knop

UITVOERING	DIAMETER	HOOGTE	BEVESTIGING	ARTIKEL NR.	SNELCODE
Zwart	60mm	38mm	M4 vijs	0706ZW525060060	20135



OVAAL knop zwart

UITVOERING	DIAMETER	HOOGTE	BEVESTIGING	ARTIKEL NR.	SNELCODE
Zwart	41mm	32mm	M6 vijs	0730 586-41 ZWX	04113
Zwart	51mm	44mm	M6 vijs	0730 594-51 ZW	08113



T-648 knop

UIVOERING	DIAMETER	HOOGTE	BEVESTIGING	ARTIKEL NR.	SNELCODE
Zwart	63mm	40mm	M4 vijs	0730 6480063 ZW	04110



KRAANKOP

UITVOERING	DIAMETER	HOOGTE	BEVESTIGING	ARTIKEL NR.	SNELCODE
Zwart	45mm	34mm	M6 vijs	0730 603-45 ZWX	04114
Zwart	55mm	38mm	M6 vijs	0730 603-55 ZWX	11114



DRAADKNOP 564

UIVOERING	DIAMETER	HOOGTE	BEVESTIGING	ARTIKEL NR.	SNELCODE
Zwart	34mm	52mm	M4 vijs	0730 564 ZW	03115



DRAADKNOP 779

UITVOERING	DIAMETER	HOOGTE	BEVESTIGING	ARTIKEL NR.	SNELCODE
Zwart	67mm	52mm	M4 vijs	0730 779/67 ZW	06115
Zwart	85mm	52mm	M4 vijs	0730 779 ZW	09115



DRAADGREEP 878

UITVOERING	BOORAFSTAND	OVERMETEN	HOOGTE	BEVESTIGING	ARTIKEL NR.	SNELCODE
Zwart	96mm	112mm	47mm	M4 vijs	0730 878/96 ZW	12115
Zwart	128mm	146mm	57mm	M4 vijs	0730 878/142 ZW	15115



KNOP 531

UITVOERING	DIAMETER	HOOGTE	BEVESTIGING	ARTIKEL NR.	SNELCODE
Zwart	30mm	30mm	M4 vijs	0730 531-30 ZWX	02109

F

BLACK AND WHITE COLLECTION



KNOP 605

UITVOERING	DIAMETER	HOOGTE	BEVESTIGING	ARTIKEL NR.	SNELCODE
Zwart	35mm	38mm	M6 vijs	0730 605-35 ZWX	08109



KNOP 637

UITVOERING	DIAMETER	HOOGTE	BEVESTIGING	ARTIKEL NR.	SNELCODE
Zwart	67mm	40mm	M6 vijs	0730 6370067 ZW	04111



KNOP 639

UITVOERING	DIAMETER	HOOGTE	BEVESTIGING	ARTIKEL NR.	SNELCODE
Zwart	36mm	30mm	M4 vijs	0730 6390036 ZX	07111

F



KNOP 641

UITVOERING	DIAMETER	HOOGTE	BEVESTIGING	ARTIKEL NR.	SNELCODE
Zwart	38mm	32mm	M4 vijs	0730 6410038 ZX	10111



T-GREEP 940

UITVOERING	BOORAFSTAND	OVERMETEN	HOOGTE	DIAMETER	BEVESTIGING	ARTIKEL NR.	SNELCODE
Zwart	96mm	160mm	40mm	12mm	M4 vijs	0730 940-96 ZW	08110
Zwart	128mm	190mm	40mm	12mm	M4 vijs	0730 940-128 ZW	12110



INFREESGREEP 903

UITVOERING	DIAMETER	BEVESTIGING	ARTIKEL NR.	SNELCODE
Zwart	40X120mm	Houtvijs + frezing	0730 9030120ZW	03125



SCHELP 583

UITVOERING	HOOGTE	OVERMETEN	BEVESTIGING	ARTIKEL NR.	SNELCODE
Zwart	42mm	93mm	Houtvijs	0730 583-93 ZW	04123

F

Gietijzeren knoppen & grepen zwart

Deze knoppen en grepen roepen herinneringen op aan vroeger. Stoofpot op het vuur, Leuvense stoof... Ze verwijzen niet alleen naar de warmte van die tijd, maar ook naar de duurzaamheid en degelijkheid van toen. Een iets grovere afwerking met lichte korrel als accent maar tevens als blijk van authenticiteit.



PROVENCE gietijzer zwart

UITVOERING	BOORAFSTAND	OVERMETEN	HOOGTE	BEVESTIGING	ARTIKEL NR.	SNELCODE
Greep	160mm	179mm	38mm	M4 vijs	0706FP30001-95	30001



ART gietijzer zwart

UITVOERING	BOORAFSTAND	OVERMETEN	HOOGTE	BEVESTIGING	ARTIKEL NR.	SNELCODE
Greep	96mm	117mm	30mm	M4 vijs	0706FP30002-95	30002



INK gietijzer zwart

UITVOERING	BOORAFSTAND	OVERMETEN	HOOGTE	BEVESTIGING	ARTIKEL NR.	SNELCODE
Knop	32mm	64mm	30mm	M4 vijs	0706FP30004-95	30004



G

FLEUR gietijzer zwart

UITVOERING	DIAMETER	HOOGTE	BEVESTIGING	ARTIKEL NR.	SNELCODE
Knop	46mm	30mm	M4 vijs	0706FP30003-95	30003



PEN gietijzer zwart

UITVOERING	BOORAFSTAND	OVERMETEN	HOOGTE	BEVESTIGING	ARTIKEL NR.	SNELCODE
Greep	128mm	183mm	32mm	M4 vijs	0706FP30007-95	30007



G

PAGODA gietijzer zwart

ARTIKEL	BOORAFSTAND	OVERMETEN	HOOGTE	BEVESTIGING	ARTIKEL NR.	SNELCODE
Knop	32mm	44mm	33mm	M4 vijs	0706FP30006-95	30006
Greep	160mm	173mm	38mm	M4 vijs	0706FP30006X-95	30008



Technische Fiche



FIRM (gietijzer look) zamak zwart

ARTIKEL	BOORAFSTAND	OVERMETEN	HOOGTE	BEVESTIGING	ARTIKEL NR.	SNELCODE
Knop	(1 boorgat)	46mm	30mm	M4	VIE0506-KNOP-ZW	50602
Schelp	64mm	94mm	28mm	M4	VIE0506-SCH-ZW	50601
Greep	64mm	94mm	30mm	M4	VIE0506-064-ZW	50664
Greep	96mm	126mm	30mm	M4	VIE0506-096-ZW	50696
Greep	160mm	190mm	30mm	M4	VIE0506-160-ZW	50616
Greep	320mm	350mm	30mm	M4	VIE0506-320-ZW	50632

Technische Fiche



OTO (gietijzer look) zamak zwart

ARTIKEL	BOORAFSTAND	OVERMETEN	DIAMETER	HOOGTE	BEVESTIGING	ARTIKEL NR.	SNELCODE
Knop	/	60mm	40mm	37mm	M4 vijs	VIE0553-060-ZW	55301
Greep	128mm	168mm	/	37mm	M4 vijs	VIE0553-128-ZW	55302

Darby Doors knoppen & grepen

Voor onze steel look zwarte kaderdeuren Darby Doors hebben we een selectie grepen samen gesteld uit ons basis programma en uitgebreid met een eigen collectie Darby knoppen en grepen die gelakt werden in identiek dezelfde lak als onze Darby Doors. Deze collectie kwam tot stand door een nauw samenwerkingsverband met de studenten van Campus De Vesten. Zij hebben op onze vraag dit project opgestart, ontworpen, gerealiseerd en geproduceerd.

Ze passen perfect bij onze Darby Doors. Niet alleen qua design en esthetiek maar ook technisch, gezien de geringe breedte van het kaderprofiel. Ze verhogen daardoor de functionaliteit van de kaderdeur zonder inbreuk te plegen op het design.

Bij de DORA knop voorzien we een excentrische boring, waardoor deze makkelijk kan gemonteerd worden in ons Darby Door profiel en tevens gecentreerd kan worden op het profiel.

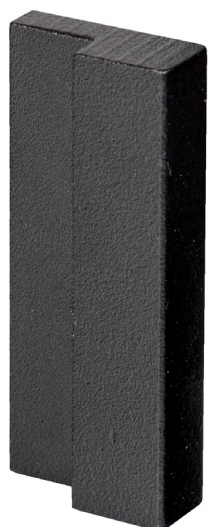

TOBIAS greep

TYPE	BOORAFSTAND	OVERMETEN	HOOGTE	ARTIKEL NR.	SNELCODE
Mat zwart gelakt	32mm	40mm	30mm	0706 DARBY 1	12155
Mat zwart gelakt	32mm	70mm	30mm	0706 DARBY 2	12156
Mat wit gelakt	32mm	40mm	30mm	0706 DARBY 1W	12160
Mat wit gelakt	32mm	70mm	30mm	0706 DARBY 2W	12161



DORA knop

UITVOERING	BOORGAT	DIAMETER	HOOGTE	ARTIKEL NR.	SNELCODE
Mat zwart gelakt	excentrisch	14mm	20mm	0706 DARBY 4	12158
Mat wit gelakt	excentrisch	14mm	20mm	0706 DARBY 4W	12163

H



SCOPE knop zwart

UITVOERING	LENGTE	HOOGTE	DIAMETER	BEVESTIGING	ARTIKEL NR.	SNELCODE
Zwart	20mm	30mm	16mm	M4 vijs	0706FP543KN-ZW	05034

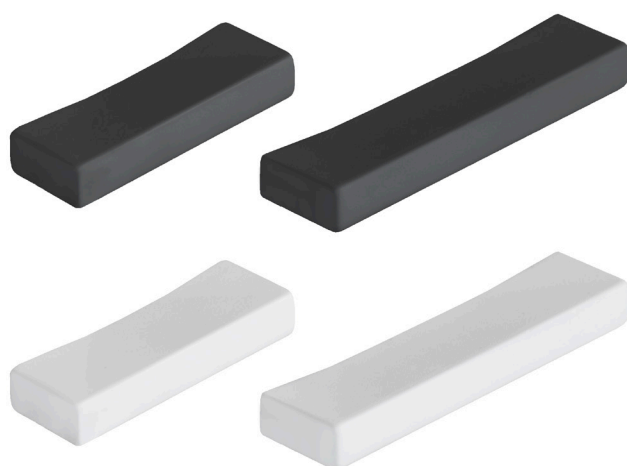

BLOK greep zwart & wit

UITVOERING	BOORAFSTAND	LENGTE X DIKTE	HOOGTE	BEVESTIGING	ARTIKEL NR.	SNELCODE
Zwart	32mm	55x10mm	18mm	M4 vijs	0706V7483.032	20116
Zwart	64mm	85x11mm	18mm	M4 vijs	0706V7482.032	20216
Zwart	96mm	115x12mm	18mm	M4 vijs	0706V7481.032	20316
Wit	32mm	55x10mm	18mm	M4 vijs	0706V7483.292	20416
Wit	64mm	85x11mm	18mm	M4 vijs	0706V7482.292	20516
Wit	96mm	115x12mm	18mm	M4 vijs	0706V7481.292	20616



OLIJF knop zwart

DIAMETER	HOOGTE	BEVESTIGING	ARTIKEL NR.	SNELCODE
36mm	32mm	M4 vijs	0730 599-36 ZWX	05112



ROND knop zwart & wit

UITVOERING	DIAMETER	HOOGTE	BEVESTIGING	ARTIKEL NR.	SNELCODE
Zwart	15mm	22mm	M4 vijs	0706V8162.032	20128
Wit	15mm	22mm	M4 vijs	0706V8162.292	20328



Technische Fiche



EDGE STRAIGHT greep

UITVOERING	OVERMETEN	BOORAFSTAND	BOORGATEN	BREEDTE	BEVESTIGING	ARTIKEL NR.	SNELCODE
Inox look	40mm	20mm	2	41mm	M4	0706FP41972-40I	01062
Inox look	100mm	60mm	2	41mm	M4	0706FP41972100I	41970
Inox look	200mm	80mm	3	41mm	M4	0706FP41972-20I	02062
Inox look	350mm	160mm	3	41mm	M4	0706FP41972-35I	03062
Inox look	600mm	160mm	4	41mm	M4	0706FP41972600I	32602
Inox look	1200mm	160mm	7	41mm	M4	0706FP41972912I	32102

NIEUW!

UITVOERING	OVERMETEN	BOORAFSTAND	BOORGATEN	BREEDTE	BEVESTIGING	ARTIKEL NR.	SNELCODE
Messing kleur	40mm	20mm	2	41mm	M4	0706FP41972-40M	11062
Messing kleur	100mm	60mm	2	41mm	M4	0706FP41972100M	41976
Messing kleur	200mm	80mm	3	41mm	M4	0706FP41972200M	18062
Messing kleur	350mm	160mm	3	41mm	M4	0706FP41972350M	25062
Messing kleur	600mm	160mm	4	41mm	M4	0706FP41972600M	32601
Messing kleur	1200mm	160mm	7	41mm	M4	0706FP41972912M	32101

NIEUW!

UITVOERING	OVERMETEN	BOORAFSTAND	BOORGATEN	BREEDTE	BEVESTIGING	ARTIKEL NR.	SNELCODE
Zwart mat	40mm	20mm	2	41mm	M4	0706FP41972-40Z	30062
Zwart mat	100mm	60mm	2	41mm	M4	0706FP41972100Z	41972
Zwart mat	200mm	80mm	3	41mm	M4	0706FP41972200Z	31062
Zwart mat	350mm	160mm	3	41mm	M4	0706FP41972350Z	32062
Zwart mat	600mm	160mm	4	41mm	M4	0706FP41972600Z	32603
Zwart mat	1200mm	160mm	7	41mm	M4	0706FP41972912Z	32103

NIEUW!

UITVOERING	OVERMETEN	BOORAFSTAND	BOORGATEN	BREEDTE	BEVESTIGING	ARTIKEL NR.	SNELCODE
Rose gold	40mm	20mm	2	41mm	M4	0706FP41972-40R	12062
Rose gold	200mm	80mm	3	41mm	M4	0706FP41972200R	19062
Rose gold	350mm	160mm	3	41mm	M4	0706FP41972350R	26062

UITVOERING	OVERMETEN	BOORAFSTAND	BOORGATEN	BREEDTE	BEVESTIGING	ARTIKEL NR.	SNELCODE
Wit	40mm	20mm	2	41mm	M4	0706FP41972-40W	13062
Wit	100mm	60mm	2	41mm	M4	0706FP41972100W	41973
Wit	200mm	80mm	3	41mm	M4	0706FP41972200W	20062
Wit	350mm	160mm	3	41mm	M4	0706FP41972350W	27062

Technische Fiche



WAY greep

UITVOERING	BOORAFSTAND	OVERMETEN	ARTIKEL NR.	SNELCODE
ALU mat	32mm	50mm	VIE0518-0050-A	51801
ALU mat	64mm	100mm	VIE0518-0100-A	51806
ALU mat	128mm	200mm	VIE0518-0200-A	51811
ALU mat	320mm	400mm	VIE0518-0400-A	51816
ALU mat	368/736mm	800mm	VIE0518-0800-A	51821
ALU mat	352/1056mm	1100mm	VIE0518-1100-A	51826
Brons	32mm	50mm	VIE0518-0050-B	51802
Brons	64mm	100mm	VIE0518-0100-B	51807
Brons	128mm	200mm	VIE0518-0200-B	51812
Brons	320mm	400mm	VIE0518-0400-B	51817
Brons	368/736mm	800mm	VIE0518-0800-B	51822
Brons	352/1056mm	1100mm	VIE0518-1100-B	51827
Inox	32mm	50mm	VIE0518-0050-I	51803
Inox	64mm	100mm	VIE0518-0100-I	51808
Inox	128mm	200mm	VIE0518-0200-I	51813
Inox	320mm	400mm	VIE0518-0400-I	51818
Inox	368/736mm	800mm	VIE0518-0800-I	51823
Inox	352/1056mm	1100mm	VIE0518-1100-I	51828
Wit	32mm	50mm	VIE0518-0050-W	51804
Wit	64mm	100mm	VIE0518-0100-W	51809
Wit	128mm	200mm	VIE0518-0200-W	51814
Wit	320mm	400mm	VIE0518-0400-W	51819
Wit	368/736mm	800mm	VIE0518-0800-W	51824
Wit	352/1056mm	1100mm	VIE0518-1100-W	51829
Zwart	32mm	50mm	VIE0518-0050-Z	51805
Zwart	64mm	100mm	VIE0518-0100-Z	51810
Zwart	128mm	200mm	VIE0518-0200-Z	51815
Zwart	320mm	400mm	VIE0518-0400-Z	51820
Zwart	368/736mm	800mm	VIE0518-0800-Z	51825
Zwart	352/1056mm	1100mm	VIE0518-1100-Z	51830

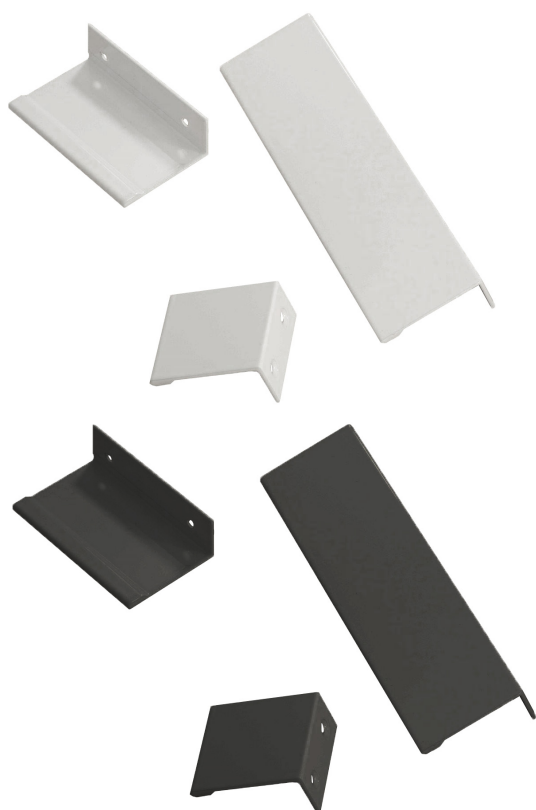

L-GREEP gelakt in wit of zwart

UITVOERING	OVERMETEN	DIKTE	AANTAL BORINGEN	BEVESTIGING	ARTIKEL NR.	SNELCODE
Wit gelakt MAT	40mm	1.5mm	2	Schroef	SGK.35159	10064
Wit gelakt MAT	70mm	1.5mm	2	Schroef	SGK.35160	11064
Wit gelakt MAT	150mm	1.5mm	3	Schroef	SGK.35161	12064
Wit gelakt MAT	300mm	1.5mm	3	Schroef	SGK.35162	13064
Wit gelakt MAT	500mm	1.5mm	3	Schroef	SGK.35163	14064
Wit gelakt MAT	1000mm	1.5mm	4	Schroef	SGK.35201	35201
Zwart gelakt MAT	40mm	1.5mm	2	Schroef	SGK.35164	15064
Zwart gelakt MAT	70mm	1.5mm	2	Schroef	SGK.35165	16064
Zwart gelakt MAT	150mm	1.5mm	3	Schroef	SGK.35166	17064
Zwart gelakt MAT	300mm	1.5mm	3	Schroef	SGK.35167	18064
Zwart gelakt MAT	500mm	1.5mm	3	Schroef	SGK.35168	19064
Zwart gelakt MAT	1000mm	1.5mm	4	Schroef	SGK.35202	35202

Zwarte houtvijzen 3.0x16 - zie pagina N 2



FLAT greep

UITVOERING	BOORAFSTAND	OVERMETEN	HOOGTE	DIAMETER	BEVESTIGING	ARTIKEL NR.	SNELCODE
Zwart RAL9005	128mm	143mm	34mm	8mm	M4 vijs	0706FP51286-128Z	51128
Zwart RAL9005	192mm	207mm	34mm	8mm	M4 vijs	0706FP51286-192Z	51192
Zwart RAL9005	256mm	271mm	34mm	8mm	M4 vijs	0706FP51286-256Z	51256
Zwart RAL9005	448mm	463mm	34mm	8mm	M4 vijs	0706FP51286-448Z	51448
Wit RAL9010	128mm	143mm	34mm	8mm	M4 vijs	0706W512860128	37355

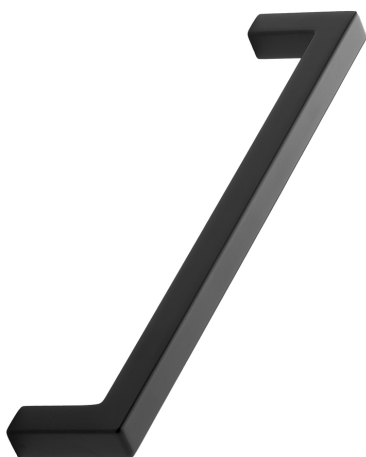

SQUARE greep zamak 10 x 10mm

UITVOERING	BOORAFSTAND	LENGTE X HOOGTE	BEVESTIGING	ARTIKEL NR.	SNELCODE
Mat zwart	128mm	138x32mm	M4 vijs	0706FP51036-128-ZW	51036
Mat zwart	160mm	170x32mm	M4 vijs	0706FP51036-160-ZW	51037
Mat zwart	224mm	234x32mm	M4 vijs	0706FP51036-224-ZW	51038
Mat zwart	320mm	330x32mm	M4 vijs	0706FP51036-320-ZW	51039
Mat zwart	448mm	458x32mm	M4 vijs	0706FP51036-448-ZW	51040

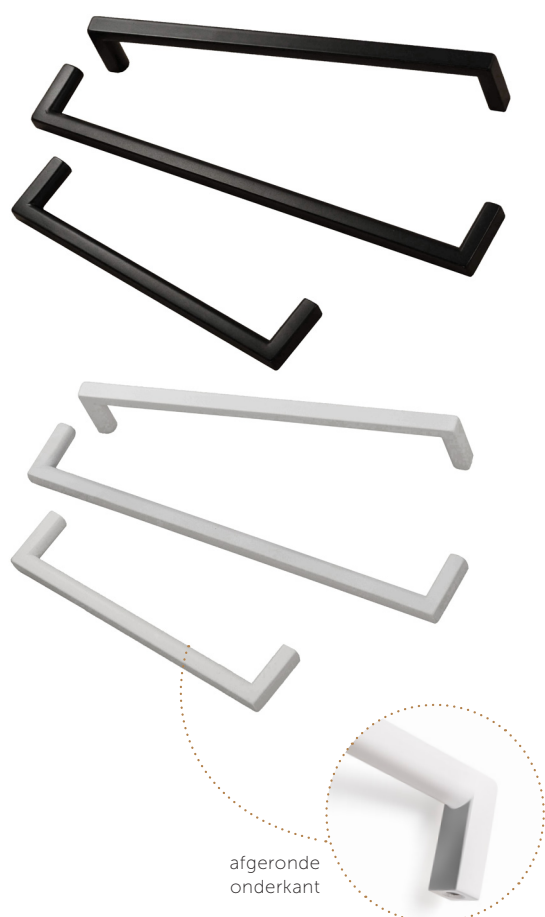

VERSTEEKGREEP wit & zwart

UITVOERING	BOORAFSTAND	OVERMETEN	HOOGTE	DIAMETER	BEVESTIGING	ARTIKEL NR.	SNELCODE
Zwart	128mm	136mm	28mm	8mm	M4 vijs	0706V6765.032	20112
Zwart	160mm	168mm	28mm	8mm	M4 vijs	0706V6764.032	20212
Zwart	192mm	200mm	28mm	8mm	M4 vijs	0706V6763.032	20312
Zwart	320mm	328mm	28mm	8mm	M4 vijs	0706V6761.032	20412
Wit	128mm	136mm	28mm	8mm	M4 vijs	0706V6765.292	20512
Wit	160mm	168mm	28mm	8mm	M4 vijs	0706V6764.292	20612
Wit	192mm	200mm	28mm	8mm	M4 vijs	0706V6763.292	20712
Wit	320mm	328mm	28mm	8mm	M4 vijs	0706V6761.292	20812

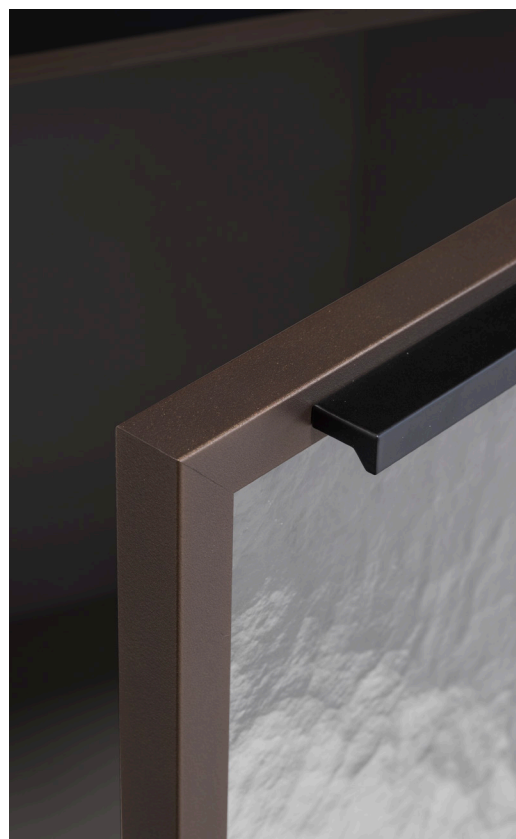

ANGLE greep

UITVOERING	BOORAFSTAND	OVERMETEN	HOOGTE	BEVESTIGING	ARTIKEL NR.	SNELCODE
Mat wit	64mm	100mm	11mm	M4	VIE0077-100-WIT	77008
Mat wit	128mm	200mm	11mm	M4	VIE0077-200-WIT	77009
Mat wit	192mm	300mm	11mm	M4	VIE0077-300-WIT	77010
Mat wit	256mm	400mm	11mm	M4	VIE0077-400-WIT	77011
Mat wit	416mm	500mm	11mm	M4	VIE0077-500-WIT	77012
Mat wit	480mm	600mm	11mm	M4	VIE0077-600-WIT	77013
Mat wit	640mm	900mm	11mm	M4	VIE0077-900-WIT	77014
Mat wit	1440mm	1480mm	11mm	M4	VIE0077-1440-WIT	77023
Mat zwart	64mm	100mm	11mm	M4	VIE0077-100-ZW	77015
Mat zwart	128mm	200mm	11mm	M4	VIE0077-200-ZW	77016
Mat zwart	192mm	300mm	11mm	M4	VIE0077-300-ZW	77017
Mat zwart	256mm	400mm	11mm	M4	VIE0077-400-ZW	77018
Mat zwart	416mm	500mm	11mm	M4	VIE0077-500-ZW	77019
Mat zwart	480mm	600mm	11mm	M4	VIE0077-600-ZW	77020
Mat zwart	640mm	900mm	11mm	M4	VIE0077-900-ZW	77021
Mat zwart	1440mm	1480mm	11mm	M4	VIE0077-1440-ZW	77022

Outdoor collectie

knoppen & grepen voor
buitenkeukens

Een aantrekkelijke collectie samengesteld voor meubels die al eens in weer en wind staan. De messing basis die geen ijzer bevat en dus niet kan roesten wordt gelakt in een weerbestendige maar aantrekkelijke oud zilver antiek lak. Ideaal voor vochtige omgevingen zoals voor buitenkeukens, maar ook perfect in een poolhouse.

Deze warme oud zilver antiek uitvoering wordt ondertussen ook zeer gesmaakt in binnenkeukens of meubels, vooral in combinatie met houtprinten.



Dock knop outdoor

UITVOERING	DIAMETER	HOOGTE	BEVESTIGING	ARTIKEL NR.	SNELCODE
Oud zilver antiek	32mm	32mm	M4	0730 650-32 OZX	01127



Raman knop outdoor

UITVOERING	DIAMETER	HOOGTE	BEVESTIGING	ARTIKEL NR.	SNELCODE
Oud zilver antiek	30mm	26mm	M4	0730 529-30 OZX	02127



Pure knop outdoor

UITVOERING	DIAMETER	HOOGTE	BEVESTIGING	ARTIKEL NR.	SNELCODE
Oud zilver antiek	30mm	25mm	M4	0730 598-30 OZX	03127



Olijf knop outdoor

UITVOERING	DIAMETER	HOOGTE	BEVESTIGING	ARTIKEL NR.	SNELCODE
Oud zilver antiek	36mm	32mm	M4 vijs	0730 599-36 OZX	01126
Oud zilver antiek	45mm	37mm	M6 vijs	0730 599-45 OZX	02126
Oud zilver antiek	54mm	42mm	M6 vijs	0730 599-54 OZX	03126
Oud zilver antiek	70mm	47mm	M6 vijs	0730 599-70 OZA	04126



T-knop knop outdoor

UITVOERING	DIAMETER	HOOGTE	BEVESTIGING	ARTIKEL NR.	SNELCODE
Oud zilver antiek	63mm	43mm	M4	0730 648-63 OZA	01128



Greep 940 greep outdoor

UITVOERING	BOORAFSTAND	OVERMETEN	HOOGTE	BEVESTIGING	ARTIKEL NR.	SNELCODE
Oud zilver antiek	96mm	160mm	36mm	M4	0730 940-096 ZA	03128
Oud zilver antiek	128mm	192mm	40mm	M4	0730 940-128 ZA	04128



Kraan knop outdoor

UITVOERING	DIAMETER	HOOGTE	BEVESTIGING	ARTIKEL NR.	SNELCODE
Oud zilver antiek	45mm	36mm	M4	0730 603-45 OZX	01130



Greep 939 greep outdoor

UITVOERING	BOORAFSTAND	OVERMETEN	HOOGTE	BEVESTIGING	ARTIKEL NR.	SNELCODE
Oud zilver antiek	64mm	128mm	38mm	M4	0730 939-064 ZA	05128
Oud zilver antiek	96mm	156mm	40mm	M4	0730 939-096 ZA	06128



Ovaal 41mm knop outdoor

UITVOERING	DIAMETER	HOOGTE	BEVESTIGING	ARTIKEL NR.	SNELCODE
Oud zilver antiek	41mm	36mm	M4	0730 586-41 OZX	01129



Ovaal 51mm knop outdoor

UITVOERING	DIAMETER	HOOGTE	BEVESTIGING	ARTIKEL NR.	SNELCODE
Oud zilver antiek	51mm	45mm	M6 vijs	0730 594-51 OZX	02129



Kjell knop outdoor

UITVOERING	DIAMETER	HOOGTE	BEVESTIGING	ARTIKEL NR.	SNELCODE
Oud zilver antiek	29mm	32mm	M4	0730 654-29 OZX	03129



Arc knop outdoor

UITVOERING	DIAMETER	HOOGTE	BEVESTIGING	ARTIKEL NR.	SNELCODE
Oud zilver antiek	26mm	24mm	M6 vijs	0730 646-26 OZX	02130



Schelp outdoor

UITVOERING	OVERMETEN	HOOGTE	BEVESTIGING	ARTIKEL NR.	SNELCODE
Oud zilver antiek	93mm	36mm	Houtschroef	0730 583-93 OZA	01131



Bench knop outdoor

UITVOERING	AFMETINGEN	BREEDTE	BEVESTIGING	ARTIKEL NR.	SNELCODE
Oud zilver antiek	50x25mm	25mm	M4 vijls (2x)	0730 843-50 OZX	03131

Handdoekrekken & kapstokken

Zorg voor een decoratieve touch! Kapstokhaken zijn er in verschillende stijlen, materialen en ontwerpen, waardoor ze niet alleen functioneel zijn, maar ook esthetisch aantrekkelijk kunnen zijn. Ze kunnen een finishing touch toevoegen aan de algehele uitstraling van je badkamer of dressing en dienen als decoratieve accenten. Of je nu kiest voor traditionele haken, moderne aluminium haken of iets met een speels design, kapstokhaken kunnen een persoonlijk tintje geven aan de badkamerinrichting.

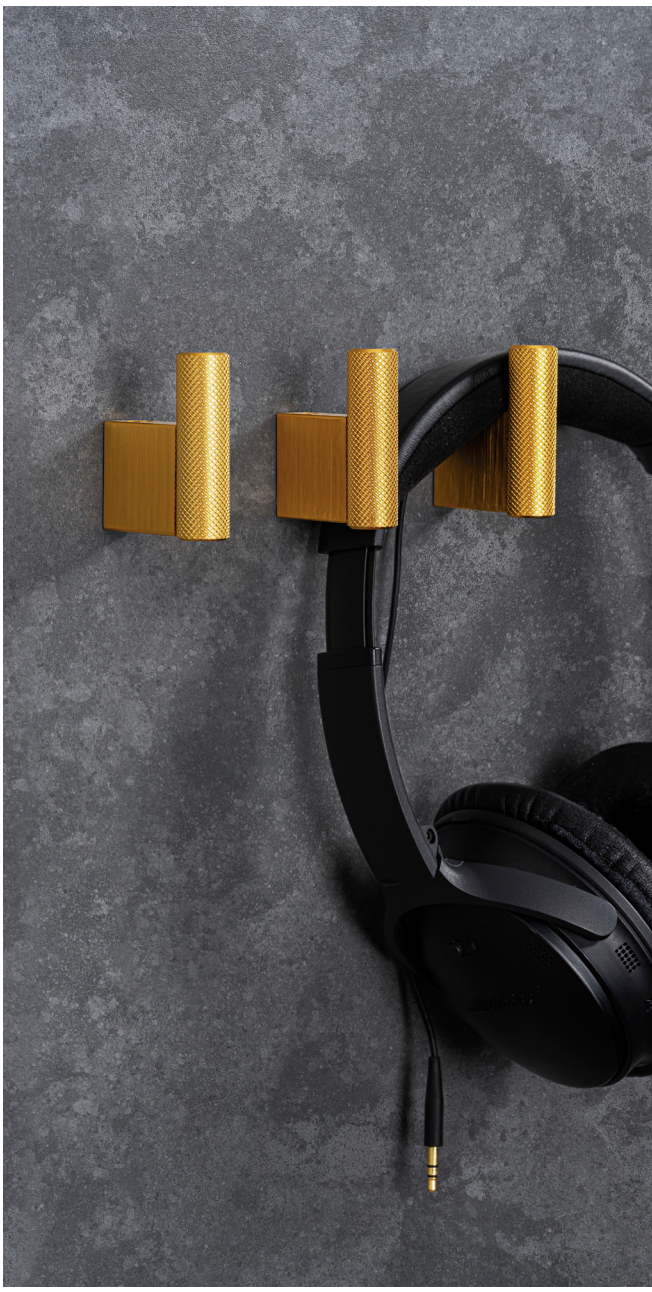

GRAF kapstokhaak

UITVOERING	HOOGTE	DIEPTE	BREEDTE	ARTIKEL NR.	SNELCODE
Inox look	50mm	41mm	14mm	VIE7009-IL	70091
Goud	50mm	41mm	14mm	VIE7009-GO	70092
Zwart	50mm	41mm	14mm	VIE7009-ZW	70093

Ook beschikbaar als knop en greep, zie pagina A 17.

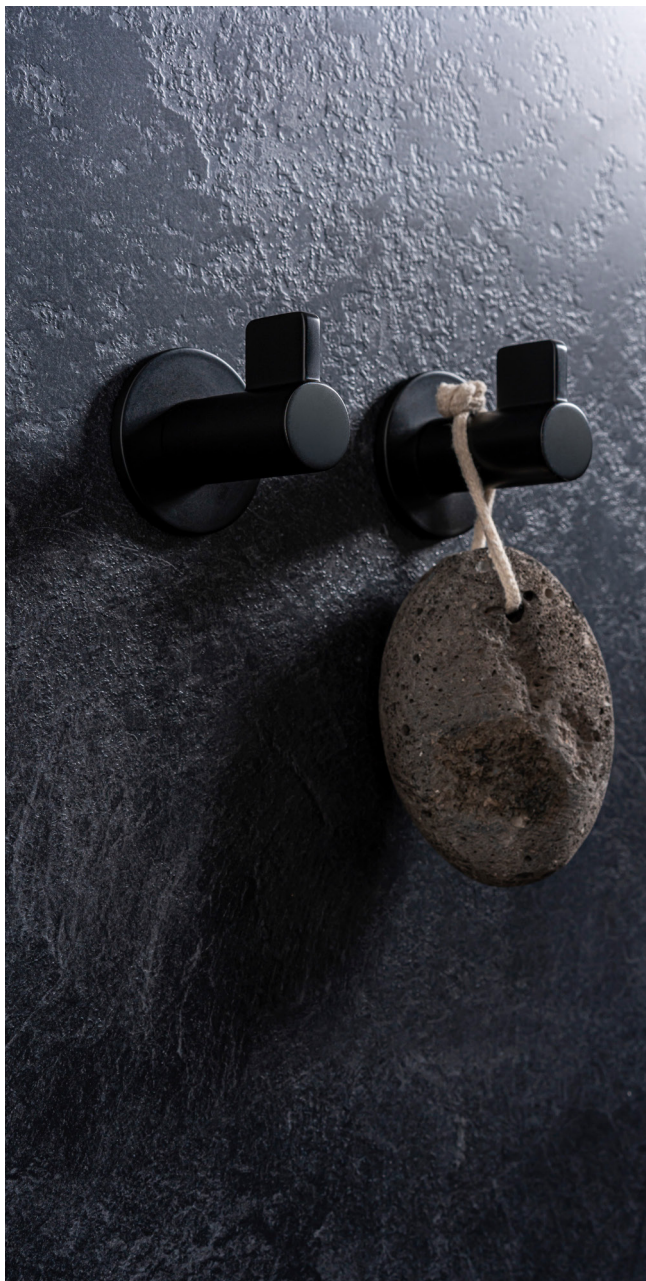

FIN kapstokhaak

UITVOERING	DIAMETER	DIEPTE	HOOGTE	ARTIKEL NR.	SNELCODE
Zwart	50mm	52mm	55mm	VIE7010-ZW	70101
Wit	50mm	52mm	55mm	VIE7010-WIT	70102

Verpakt met montagebeslag



EQUIS kapstokhaak

UITVOERING	AFMETINGEN	HOOGTE	ARTIKEL NR.	SNELCODE
Chrome glans	80x80mm	60mm	VIE7027-CG	70271
Glans zwart	80x80mm	60mm	VIE7027-ZN	70272
Koper	80x80mm	60mm	VIE7027-KOP	70273
Messing	80x80mm	60mm	VIE7027-MG	70274
Mat wit	80x80mm	60mm	VIE7027-MW	70275
Mat zwart	80x80mm	60mm	VIE7027-MZ	70276

Ook beschikbaar als knop, zie pagina D 7.



BELT kapstokhaak

UITVOERING	AFMETINGEN	DIEPTE	ARTIKEL NR.	SNELCODE
Mat wit	22x114mm	65mm	VIE7039-MW	70391
Mat zwart	22x114mm	65mm	VIE7039-MZ	70392
Mos grijs	22x114mm	65mm	VIE7039-MG	70393
Woud groen	22x114mm	65mm	VIE7039-WG	70394
Mokka bruin	22x114mm	65mm	VIE7039-MB	70395
Vulkaan rood	22x114mm	65mm	VIE7039-VR	70396

Verpakt met montagebeslag. Ook beschikbaar als knop, zie pagina A 6.

J

KAPSTOKKEN EN HANDDOEKREKKEN



ROUND kapstokhaak

UITVOERING	DIAMETER	DIEPTE	ARTIKEL NR.	SNELCODE
Goud	28mm	45mm	VIE7016-GO	70161
Zwart	28mm	45mm	VIE7016-ZW	70162

Verpakt met montagebeslag

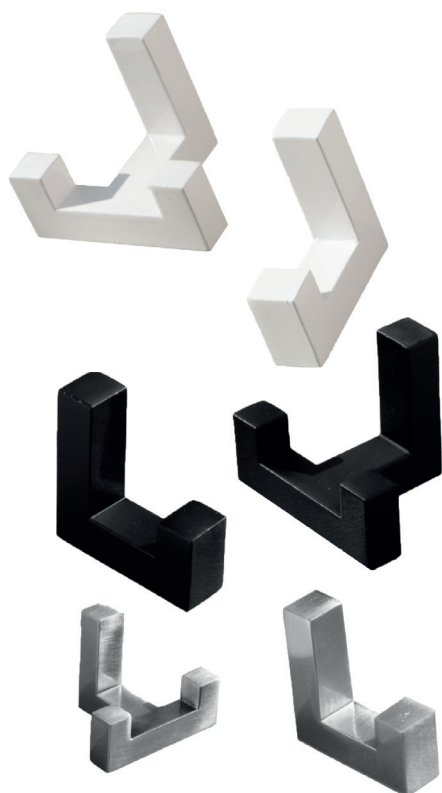

Kapstokhaak inox look, chromé, wit en zwart

UITVOERING	TYPE	LENGTE	DIEPTE	BREEDTE	ARTIKEL NR.	SNELCODE
Zwart	Enkel	12mm	40mm	40mm	0706GR KAPEZ	70061
Wit	Enkel	12mm	40mm	40mm	0706GR KAPEW	70062
Inox look	Enkel	12mm	40mm	40mm	0706GR KAPEI	70063
Chromé	Enkel	12mm	40mm	40mm	0706GR KAPEC	70064
Zwart	Dubbel	52mm	40mm	40mm	0706GR KAPDZ	70065
Wit	Dubbel	52mm	40mm	40mm	0706GR KAPDW	70066
Inox look	Dubbel	52mm	40mm	40mm	0706GR KAPDI	70067
Chromé	Dubbel	52mm	40mm	40mm	0706GR KAPDC	70068

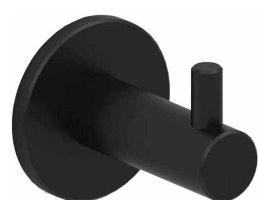

Kapstokhaak op rozet

UITVOERING	DIAMETER	HOOGTE	ARTIKEL NR.	SNELCODE
Inox	35mm	40mm	1200 CR.BHP35	70069
Goud	35mm	40mm	1200 CR.BHP35G	70070
Mat zwart	35mm	40mm	1200 CR.BHP35Z	70071

Verpakt met montagebeslag.



COMO kapstokhaak

UITVOERING	DIAMETER	HOOGTE	ARTIKEL NR.	SNELCODE
Glans chrome	41mm	25mm	VIE7017-CG	70171
Glans zwart	41mm	25mm	VIE7017-ZN	70172
Glans koper	41mm	25mm	VIE7017-KOPGL	70173
Glans messing	41mm	25mm	VIE7017-MES	70174
Mat chrome	41mm	25mm	VIE7017-CM	70175
Inox look	41mm	25mm	VIE7017-IL	70176
Mat koper	41mm	25mm	VIE7017-KOPM	70177
Mat goud	41mm	25mm	VIE7017-GOUD	70178
Mat wit	41mm	25mm	VIE7017-MW	70179
Mat zwart	41mm	25mm	VIE7017-MZ	70180

Verpakt met montagebeslag. Ook beschikbaar als knop, zie pagina D 10.



HK02 kapstokhaak inox

UITVOERING	TYPE	HOOGTE	DIEPTE	ARTIKEL NR.	SNELCODE
Inox	enkel	85mm	65mm	1200 CR.BHPHK02	70072



HK03 kapstokhaak inox

UITVOERING	TYPE	HOOGTE	DIEPTE	ARTIKEL NR.	SNELCODE
Inox	dubbel	167mm	65mm	1200 CR.BHPHK03	70073



HK08 kapstokhaak inox

UITVOERING	TYPE	HOOGTE	DIEPTE	ARTIKEL NR.	SNELCODE
Inox	enkel	50mm	40mm	1200 CR.BHPK08	70074



HK09 kapstokhaak inox

UITVOERING	TYPE	HOOGTE	DIEPTE	ARTIKEL NR.	SNELCODE
Inox	dubbel	127mm	40mm	1200 CR.BHPK09	70075

J

J

KAPSTOKKEN EN HANDDOEKREKKEN



LIVORNO kapstokhaak

UITVOERING	HOOGTE	LENGTE	ARTIKEL NR.	SNELCODE
Goud	28mm	56mm	1200 HK35614	35614
Zwart	28mm	56mm	1200 HK35615	35615
Inox	28mm	56mm	1200 HK35616	35616



TWIST kapstokhaak draaibaar

UITVOERING	HOOGTE	DIAMETER	ARTIKEL NR.	SNELCODE
Zwart	52mm	40mm	1200 HK414102	41412
Mat chrome	52mm	40mm	1200 HK414103	41413



RINI kapstokhaak

UITVOERING	TYPE	HOOGTE	DIEPTE	ARTIKEL NR.	SNELCODE
Zwart	enkel	59mm	21mm	1200 HK39959	39959
Zwart	dubbel	141mm	19mm	1200 HK39958	39958



Handdoekrek

KLEUR	BOORAFSTAND	AFMETINGEN	BEVESTIGING	ARTIKEL NR.	SNELCODE
Aged bronze	480mm	490x32x10mm	beslag meegeleverd	HDRK 490 AB	18121
Zwart	480mm	490x32x10mm	beslag meegeleverd	HDRK 490 BK	18122
Aged gold	480mm	490x32x10mm	beslag meegeleverd	HDRK 490 GA	18123
Old silver	480mm	490x32x10mm	beslag meegeleverd	HDRK 490 O	18124



Handdoekrek voor montage binnenkant kast

UITVOERING	INBOUWDIEPTE	UITTREKBAAR	BREEDTE	ARTIKEL NR.
Aluminium	443mm	732mm	92mm	0710 350 2ZXT
Wit	443mm	732mm	92mm	0710 350 2WXT



Handdoekrek kogelgelagerd

UITVOERING	INBOUWDIEPTE	UITTREKBAAR	BREEDTE	ARTIKEL NR.
Chromé	490mm	900mm	102mm	0718 600.103.05

Antieke knoppen & grepen

Een selectie knoppen en grepen voor kopie antieke meubels of voor restauratie in typische warme uitvoeringen zoals roest vernist, zwart en antiek zilver. Ze geven een warme uitstraling en een exclusief cachet maar behouden hun functionaliteit en design. Hou er rekening mee dat verschillende van deze modellen effectief gegoten worden in zandmatrijzen en manueel worden geborsteld om het uitzonderlijke karakter te vrijwaren. Verschillen binnen eenzelfde collectie zijn dan ook mogelijk maar vormen tevens een meerwaarde naar authenticiteit. Brons antiek, een levende kleur, kan na verloop van tijd door aanraking en blootstelling aan daglicht lichtjes verkleuren.



CHATEAU knop rond

UITVOERING	BOORAFSTAND	DIAMETER	HOOGTE	BEVESTIGING	ARTIKEL NR.	SNELCODE
Brons antiek	/	30mm	30mm	M4	0706FP55512-30-BA	55512
Inox look	/	30mm	30mm	M4	0706FP55512-30-IL	55514
Messing geborsteld	/	30mm	30mm	M4	0706FP55512-30-MES	55513

CHATEAU knop ovaal

UITVOERING	BOORAFSTAND	OVERMETEN	HOOGTE	BEVESTIGING	ARTIKEL NR.	SNELCODE
Brons antiek	/	52mm	30mm	M4	0706FP55522-52-BA	55522
Inox look	/	52mm	30mm	M4	0706FP55522-52-IL	55524
Messing geborsteld	/	52mm	30mm	M4	0706FP55522-52-MES	55523

CHATEAU greep

UITVOERING	BOORAFSTAND	AFMETINGEN	HOOGTE	BEVESTIGING	ARTIKEL NR.	SNELCODE
Brons antiek	128mm	180mm	30mm	M4	0706FP55532-128-BA	55532
Inox look	128mm	180mm	30mm	M4	0706FP55532-128-IL	55534
Messing geborsteld	128mm	180mm	30mm	M4	0706FP55532-128-MES	55533

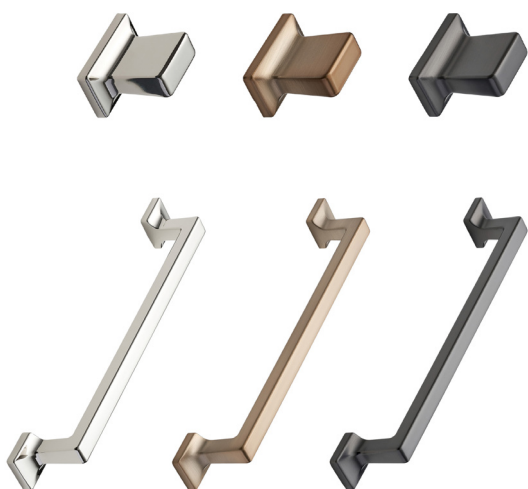

HERITAGE knop

UITVOERING	BOORAFSTAND	OVERMETEN	HOOGTE	BEVESTIGING	ARTIKEL NR.	SNELCODE
Chrome glans	16mm	36mm	31mm	M4	0706FP554920016-CHG	55492
Messing geborsteld	16mm	36mm	31mm	M4	0706FP554920016-MES	55493
Pewter	16mm	36mm	31mm	M4	0706FP554920016-PEW	55494

HERITAGE greep

UITVOERING	BOORAFSTAND	OVERMETEN	HOOGTE	BEVESTIGING	ARTIKEL NR.	SNELCODE
Chrome glans	160mm	190mm	31mm	M4	0706FP55502-160-CHG	55502
Messing geborsteld	160mm	190mm	31mm	M4	0706FP55502-160-MES	55503
Pewter	160mm	190mm	31mm	M4	0706FP55502-160-PEW	55504
Chrome glans	320mm	350mm	31mm	M4	0706FP55502-320-CHG	55505
Messing geborsteld	320mm	350mm	31mm	M4	0706FP55502-320-MES	55506
Pewter	320mm	350mm	31mm	M4	0706FP55502-320-PEW	55507





SHIP greep antiek grijs & brons

UITVOERING	BOORAFSTAND	OVERMETEN	HOOGTE	BEVESTIGING	ARTIKEL NR.	SNELCODE
Antiek grijs	128mm	165mm	37mm	M4 vijs	0706FP5296128AG	01102
Antiek brons	128mm	165mm	37mm	M4 vijs	0706FP5296128AB	02102

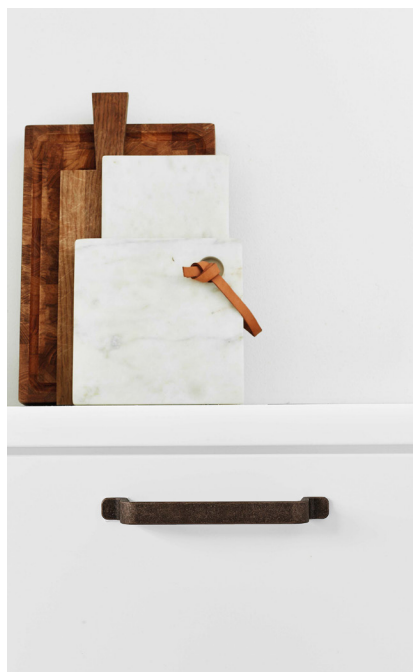

RIO greep antiek grijs & brons

UITVOERING	BOORAFSTAND	OVERMETEN	HOOGTE	BEVESTIGING	ARTIKEL NR.	SNELCODE
Antiek grijs	128mm	164mm	30mm	M4 vijs	0706FP5306128AG	03102
Antiek brons	128mm	164mm	30mm	M4 vijs	0706FP5306128AB	04102

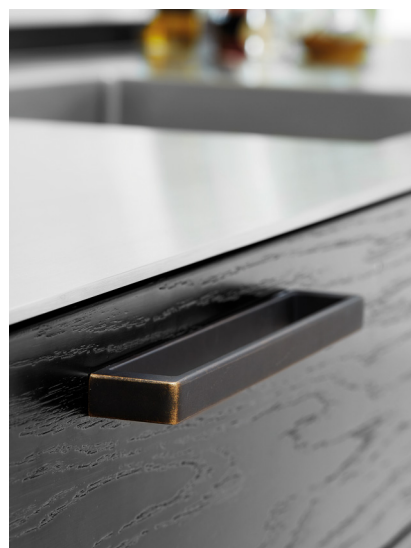

CUBICO greep antiek brons

UITVOERING	BOORAFSTAND	OVERMETEN	HOOGTE	BEVESTIGING	ARTIKEL NR.	SNELCODE
Antiek grijs	192mm	201mm	33mm	M4 vijs	0706FP5186192AG	05100
Antiek brons	192mm	201mm	33mm	M4 vijs	0706FP5186192AB	06100



BULL greep antiek brons

UITVOERING	BOORAFSTAND	OVERMETEN	HOOGTE	BEVESTIGING	ARTIKEL NR.	SNELCODE
Antiek brons	160mm	170mm	33mm	M4 vijs	0706FP5282160AB	04100

K



LOCKER greep antiek grijs & brons

UITVOERING	BOORAFSTAND	OVERMETEN	HOOGTE	BEVESTIGING	ARTIKEL NR.	SNELCODE
Antiek grijs	128mm	140mm	32mm	M4 vijs	0706FP5342128AG	01101
Antiek brons	128mm	140mm	32mm	M4 vijs	0706FP5342128AB	02101



PENDANT zwart

OMSCHRIJVING	BOORAFSTAND	AFMETINGEN	BEVESTIGING	ARTIKEL NR.	SNELCODE
Hangerknop	/	40x38mm	M4 vijs	VIE0516-040-ZW	51640
Hangergreep	128mm	139x33mm	M4 vijs	VIE0516-128-ZW	51628

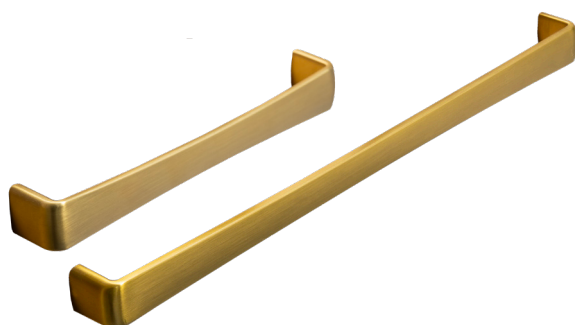

LOUIS greep goud mat

BOORAFSTAND	LENGTE X BREEDTE	HOOGTE	BEVESTIGING	ARTIKEL NR.	SNELCODE
160mm	167x22mm	25mm	M4 vijs	0706GR72393424	72394
320mm	328x22mm	25mm	M4 vijs	0706GR72393624	72396

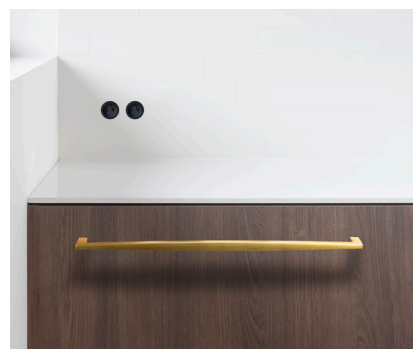

TRIANON greep goud mat

BOORAFSTAND	LENGTE X BREEDTE	HOOGTE	BEVESTIGING	ARTIKEL NR.	SNELCODE
320mm	331x10mm	28mm	M4 vijs	0706GR72267024	72267

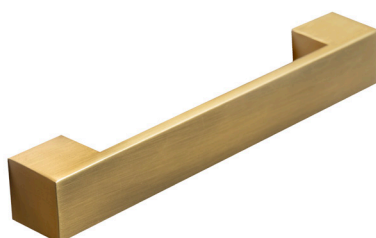

COLBERT greep goud mat

BOORAFSTAND	LENGTE X BREEDTE	HOOGTE	BEVESTIGING	ARTIKEL NR.	SNELCODE
128mm	163x24mm	25mm	M4 vijs	0706GR08634424	08634

K



OVAL SIMPLE knop antiek brons

UITVOERING	OVERMETEN	HOOGTE	BEVESTIGING	ARTIKEL NR.	SNELCODE
Antiek grijs	60mm	38 mm	M4 vijs	0706FP5250060AG	03103
Antiek brons	60mm	38 mm	M4 vijs	0706FP5250060AB	04103



BANISTER knop antiek brons

UITVOERING	DIAMETER	HOOGTE	BEVESTIGING	ARTIKEL NR.	SNELCODE
Antiek brons	33mm	43mm	M4 vijs	0706FP5339033AB	06103



SWAN greep antiek grijs & brons

UITVOERING	BOORAFSTAND	OVERMETEN	BREEDTE	BEVESTIGING	ARTIKEL NR.	SNELCODE
Antiek grijs	64mm	72mm	31mm	M4 vijs	0706FP5315064AG	01104
Antiek brons	64mm	72mm	31mm	M4 vijs	0706FP5315064AB	02104



LAND

OMSCHRIJVING	BOORAFSTAND	OVERMETEN	BREEDTE	HOOGTE	BEVESTIGING	ARTIKEL NR.	SNELCODE
Geborsteld goud	64mm	98mm	32mm	40mm	M4 vijs	VIE0494-064-GO	49465
Zwart	64mm	98mm	32mm	40mm	M4 vijs	VIE0494-064-ZW	49464

K



DRAADKNOP 564

UITVOERING	DIAMETER	HOOGTE	BEVESTIGING	ARTIKEL NR.	SNELCODE
Blank vernist	34mm	52mm	M4 vijs	0730 564 GL	01115
Roest vernist	34mm	52mm	M4 vijs	0730 564 R	02115
Zwart gelakt	34mm	52mm	M4 vijs	0730 564 ZW	03115



DRAADKNOP 779

UITVOERING	OVERMETEN	HOOGTE	BEVESTIGING	ARTIKEL NR.	SNELCODE
Roest vernist	67mm	52mm	M4 vijs	0730 779/67 RL	04115
Blank vernist	67mm	52mm	M4 vijs	0730 779/67 GL	05115
Zwart	67mm	52mm	M4 vijs	0730 779/67 ZW	06115
Roest vernist	85mm	52mm	M4 vijs	0730 779 RL	07115
Blank vernist	85mm	52mm	M4 vijs	0730 779 GL	08115
Zwart	85mm	52mm	M4 vijs	0730 779 ZW	09115



DRAADKNOP 878

UITVOERING	BOORAFSTAND	OVERMETEN	HOOGTE	BEVESTIGING	ARTIKEL NR.	SNELCODE
Roest vernist	96mm	112mm	47mm	M4 vijs	0730 878/96 RL	10115
Blank vernist	96mm	112mm	47mm	M4 vijs	0730 879/96 GL	11115
Zwart	96mm	112mm	47mm	M4 vijs	0730 878/96 ZW	12115
Roest vernist	128mm	146mm	57mm	M4 vijs	0730 878/142 RL	13115
Blank vernist	128mm	146mm	57mm	M4 vijs	0730 878/142 GL	14115
Zwart	128mm	146mm	57mm	M4 vijs	0730 878/142 ZW	15115

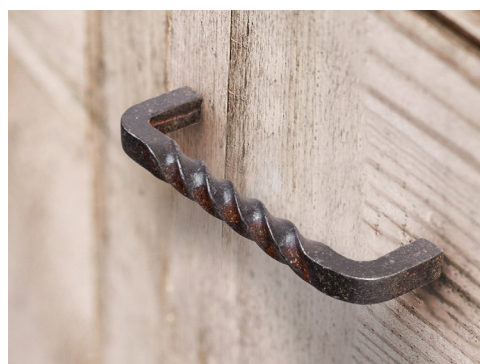

GREEP 732

UITVOERING	BOORAFSTAND	OVERMETEN	BEVESTIGING	ARTIKEL NR.	SNELCODE
Roest vernist	96mm	106mm	M4 vijs	0730 732096RL	03122

K



TWIST knop ijzer tinkleur

AFMETING	HOOGTE	BEVESTIGING	ARTIKEL NR.	SNELCODE
75x25mm	38mm	M4 vijs	0706GR08775208	01105



TWIST greep ijzer tinkleur

BOORAFSTAND	OVERMETEN	HOOGTE	DIAMETER	BEVESTIGING	ARTIKEL NR.	SNELCODE
128mm	136mm	40mm	20mm	M4 vijs	0706GR08899408	03105



BERLIN greep & knop oud tin

ARTIKEL	BOORAFSTAND	OVERMETEN	HOOGTE	DIAMETER	BEVESTIGING	ARTIKEL NR.	SNELCODE
Knop	/	/	26mm	30mm	M4 vijs	0706GR08615522	04106
Greep	96mm	104mm	26mm	14mm	M4 vijs	0706GR08541022	01106



BERLIN greep met plaat oud tin

BOORAFSTAND	OVERMETEN	HOOGTE	DIAMETER	BEVESTIGING	ARTIKEL NR.	SNELCODE
96mm	108mm	28mm	30mm	M4 vijs	0706GR08541122	02106
128mm	140mm	30mm	30mm	M4 vijs	0706GR08541222	03106

K



MOSCOW knop aluminium

UITVOERING	LENGTE X BREEDTE	HOOGTE	BEVESTIGING	ARTIKEL NR.	SNELCODE
Tinkleur	40x40mm	30mm	M4 vijs	0706GR0898734022	01108
Brons antiek	40x40mm	30mm	M4 vijs	0706GR0898734036	02108



MOSCOW greep aluminium

UITVOERING	BOORAFSTAND	OVERMETEN	HOOGTE	DIAMETER	BEVESTIGING	ARTIKEL NR.	SNELCODE
Tinkleur	128mm	155mm	29mm	25mm	M4 vijs	0706GR0898844022	03108
Brons antiek	128mm	155mm	29mm	25mm	M4 vijs	0706GR0898844036	04108



KNOP 627

UITVOERING	DIAMETER	HOOGTE	BEVESTIGING	ARTIKEL NR.	SNELCODE
Blank vernist	35mm	35mm	M6 vijs	0730 6270034GL	05119
Roest vernist	35mm	35mm	M6 vijs	0730 6270034RL	06119
Zwart	35mm	35mm	M6 vijs	0730 6270034ZW	07119
Brons antiek	35mm	35mm	M6 vijs	0730 6270034BA	08119



KNOP 628

UITVOERING	DIAMETER	HOOGTE	BEVESTIGING	ARTIKEL NR.	SNELCODE
Zwart	32mm	28mm	M4 vijs	0730 6280032ZW	18119

K



KNOP 598

UITVOERING	DIAMETER	HOOGTE	BEVESTIGING	ARTIKEL NR.	SNELCODE
Brons antiek	30mm	22mm	M4 vijs	0730 598-30 BA	03118



KNOP 637

UITVOERING	OVERMETEN	HOOGTE	BEVESTIGING	ARTIKEL NR.	SNELCODE
Roest vernist	67mm	40mm	M6 vijs	0730 637 0067 RL	01111
Blank vernist	67mm	40mm	M6 vijs	0730 637 0067 GL	02111
Brons antiek	67mm	40mm	M6 vijs	0730 637 0067 BA	03111
Zwart	67mm	40mm	M6 vijs	0730 637 0067 ZW	04111



KNOP 531 zwart

DIAMETER	HOOGTE	BEVESTIGING	ARTIKEL NR.	SNELCODE
30mm	30mm	M4 vijs	0730 531-30 ZWX	02109



KNOP 605

UITVOERING	DIAMETER	HOOGTE	BEVESTIGING	ARTIKEL NR.	SNELCODE
Zwart	35mm	38mm	M6 vijs	0730 605-35 ZWX	08109
Blank vernist	35mm	38mm	M4 vijs	0730 605-35 GLX	07109
Brons antiek	35mm	38mm	M4 vijs	0730 605-35 BA	08109

K



KNOP 639

UITVOERING	OVERMETEN	HOOGTE	BEVESTIGING	ARTIKEL NR.	SNELCODE
Blank vernist	36mm	30mm	M4 vijs	0730 639 0036 GLX	06111
Zwart	36mm	30mm	M4 vijs	0730 639 0036 ZWX	07111



KNOP 641

UITVOERING	OVERMETEN	HOOGTE	BEVESTIGING	ARTIKEL NR.	SNELCODE
Blank vernist	38mm	32mm	M4 vijs	0730 641 0038 GLX	09111
Zwart	38mm	32mm	M4 vijs	0730 6410038 ZX	10111



SCHELP 886

UITVOERING	BOORAFSTAND	OVERMETEN	BEVESTIGING	ARTIKEL NR.	SNELCODE
Tin antiek	64mm	73mm	M4 vijs	0730 8860064ZOZ	10123
Tin antiek	96mm	106mm	M4 vijs	0730 8860096ZOZ	11123



SCHELP 583

UITVOERING	OVERMETEN	HOOGTE	BEVESTIGING	ARTIKEL NR.	SNELCODE
Blank vernist	93mm	42mm	Houtvijs (inbegrepen)	0730 583-93 GL	01123
Roest vernist	93mm	42mm	Houtvijs (inbegrepen)	0730 583-93 RL	02123
Brons antiek	93mm	42mm	Houtvijs (inbegrepen)	0730 583-93 BA	03123
Zwart	93mm	42mm	Houtvijs (inbegrepen)	0730 583-93 ZW	04123
Nikkel mat	93mm	42mm	Houtvijs (inbegrepen)	0730 583-93 MV	05123
Chromé glans	93mm	42mm	Houtvijs (inbegrepen)	0730 583-93 CHR	06123



KNOP 648

UITVOERING	DIAMETER	HOOGTE	BEVESTIGING	ARTIKEL NR.	SNELCODE
Roest vernist	63mm	40mm	M4 vijs	0730 6480063 RL	01110
Blank vernist	63mm	40mm	M4 vijs	0730 6480063 GL	02110
Brons antiek	63mm	40mm	M4 vijs	0730 6480063 BA	03110
Zwart	63mm	40mm	M4 vijs	0730 6480063 ZW	04110

GREEP 940

UITVOERING	BOORAFSTAND	OVERMETEN	HOOGTE	DIAMETER	BEVESTIGING	ARTIKEL NR.	SNELCODE
Roest vernist	96mm	160mm	40mm	12mm	M4 vijs	0730 940-96 RL	05110
Blank vernist	96mm	160mm	40mm	12mm	M4 vijs	0730 940-96 GL	06110
Brons antiek	96mm	160mm	40mm	12mm	M4 vijs	0730 940-96 BA	07110
Zwart	96mm	160mm	40mm	12mm	M4 vijs	0730 940-96 ZW	08110
Roest vernist	128mm	190mm	40mm	12mm	M4 vijs	0730 940-128 RL	09110
Blank vernist	128mm	190mm	40mm	12mm	M4 vijs	0730 940-128 GL	10110
Brons antiek	128mm	190mm	40mm	12mm	M4 vijs	0730 940-128 BA	11110
Zwart	128mm	190mm	40mm	12mm	M4 vijs	0730 940-128 ZW	12110



KNOP 043

UITVOERING	LENGTE X BREEDTE	HOOGTE	BOORAFSTAND	BEVESTIGING	ARTIKEL NR.	SNELCODE
Roest vernist	50x25mm	25mm	16mm	M4 vijs (2x)	0730 043 0050 RL	01118
Brons antiek	50x25mm	25mm	16mm	M4 vijs (2x)	0730 043 0050 BA	02118



Rechthoek knop 546

UITVOERING	DIAMETER	HOOGTE	BEVESTIGING	ARTIKEL NR.	SNELCODE
Blank vernist	24mm	18mm	M4 vijs	0730 546-1924 GL	09113
Roest vernist	24mm	18mm	M4 vijs	0730 546-1924 RL	10113
Brons antiek	24mm	18mm	M4 vijs	0730 546-1924 BA	11113

K



OLIJF 599 knop 36mm - 45mm - 54mm

UITVOERING	OVERMETEN	HOOGTE	BEVESTIGING	ARTIKEL NR.	SNELCODE
Blank vernist	36mm	32mm	M4 vijs	0730 599-36 GLX	01112
Roest vernist	36mm	32mm	M4 vijs	0730 599-36 RX	02112
Brons antiek	36mm	32mm	M4 vijs	0730 599-36 BA	03112
Chromé glans	36mm	32mm	M4 vijs	0730 599-36 BC	04112
Zwart gelakt	36mm	32mm	M4 vijs	0730 599-36 ZWX	05112
Blank vernist	45mm	38mm	M4 vijs	0730 599-45 GLX	06112
Roest vernist	45mm	38mm	M4 vijs	0730 599-45 RX	07112
Brons antiek	45mm	38mm	M4 vijs	0730 599-45 BA	08112
Chromé glans	45mm	38mm	M4 vijs	0730 599-45 BC	09112
Zwart gelakt	45mm	38mm	M4 vijs	0730 599-45 ZWX	10112
Blank vernist	54mm	44mm	M4 vijs	0730 599-54 GLX	11112
Roest vernist	54mm	44mm	M4 vijs	0730 599-54 RX	12112
Brons antiek	54mm	44mm	M4 vijs	0730 599-54 BA	13112
Zwart gelakt	54mm	44mm	M4 vijs	0730 599-54 ZWX	15112



OVAAL knop 41mm - 51mm

UITVOERING	OVERMETEN	HOOGTE	BEVESTIGING	ARTIKEL NR.	SNELCODE
Blank vernist	41mm	32mm	M6 vijs	0730 586-41 GLX	01113
Roest vernist	41mm	32mm	M6 vijs	0730 586-41 RLX	02113
Brons antiek	41mm	32mm	M6 vijs	0730 586-41 BA	03113
Zwart gelakt	41mm	32mm	M6 vijs	0730 586-41 ZWX	04113
Blank vernist	51mm	44mm	M6 vijs	0730 594-51 GL	05113
Roest vernist	51mm	44mm	M6 vijs	0730 594-51 RL	06113
Brons antiek	51mm	44mm	M6 vijs	0730 594-51 BA	07113
Zwart gelakt	51mm	44mm	M6 vijs	0730 594-51 ZW	08113

K



KRAANKNOP 45mm - 55mm

UITVOERING	OVERMETEN	HOOGTE	BEVESTIGING	ARTIKEL NR.	SNELCODE
Inox	45mm	34mm	M6 vijs	0730 603-45 INX	01114
Brons antiek	45mm	34mm	M6 vijs	0730 603-45 BA	02114
Roest vernist	45mm	34mm	M6 vijs	0730 603-45 RX	03114
Zwart	45mm	34mm	M6 vijs	0730 603-45 ZWX	04114
Inox	55mm	38mm	M6 vijs	0730 603-55 INX	08114
Brons antiek	55mm	38mm	M6 vijs	0730 603-55 BA	09114
Roest vernist	55mm	38mm	M6 vijs	0730 603-55 RX	10114
Zwart	55mm	38mm	M6 vijs	0730 603-55 ZWX	11114



KRAANGREEP

UITVOERING	BOORAFSTAND	OVERMETEN	HOOGTE	BEVESTIGING	ARTIKEL NR.	SNELCODE
Inox	96mm	132mm	34mm	M6 vijs	0730 933-96 MRS	05114
Inox	128mm	164mm	34mm	M6 vijs	0730 933-128MRS	06114

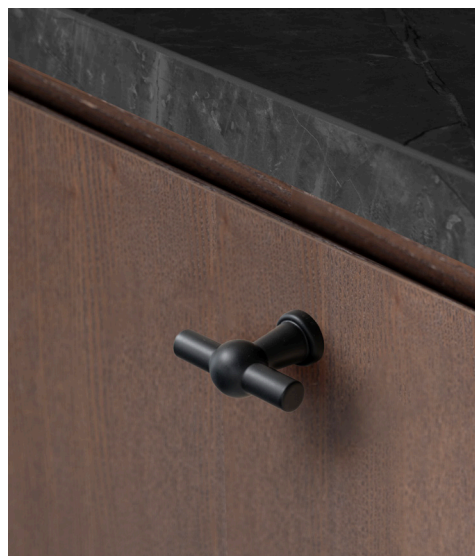

PETRA knop 46mm

UITVOERING	OVERMETEN	HOOGTE	BEVESTIGING	ARTIKEL NR.	SNELCODE
Zwart	46mm	35mm	M4 vijs	HDD 2.129.090	21290



PETRA greep 96mm

UITVOERING	BOORAFSTAND	OVERMETEN	HOOGTE	BEVESTIGING	ARTIKEL NR.	SNELCODE
Zwart	96mm	120mm	35mm	M4 vijs	HDD 2.263.090	22630

K



VANILLA wit porcelein

VORM	BOORAFSTAND	OVEREMETEN	HOOGTE	BEVESTIGING	ARTIKEL NR.	SNELCODE
Rechthoek knop	16mm	50mm	26mm	M4 vijs	0706FP601201016	05107
Rechthoek greep	96mm	140mm	26mm	M4 vijs	0706FP601201096	06107



INFREESGREEP 903 zwart

UITVOERING	DIAMETER	BEVESTIGING	ARTIKEL NR.	SNELCODE
Zwart	40X120mm	Houtvijs + frezing	0730 903 0120 ZW	03125

Projectgrepen

- economisch -

In dit hoofdstuk vindt u een selectie terug uit onze volledige catalogus, gebaseerd op een sterke prijs/kwaliteit verhouding. Deze knoppen en grepen hebben wij normaal gezien ook steeds voorradig in grotere aantallen, zodat die perfect kunnen dienen voor grotere projecten waar een kwalitatieve knop of greep wordt gevraagd binnen een beperkt budget. Door deze knoppen en grepen in grotere aantallen aan te kopen, kunnen wij deze ook zeer attractief aanbieden.



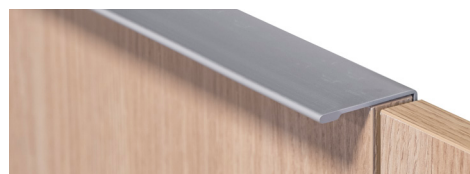

L-GREEP aluminium

UITVOERING	OVERMETEN	DIKTE	AANTAL BORINGEN	BEVESTIGING	ARTIKEL NR.	SNELCODE
ALU geanod.	40mm	1.5mm	2	Houtvijs	SGK.35154	03064
ALU geanod.	70mm	1.5mm	2	Houtvijs	SGK.35155	04064
ALU geanod.	150mm	1.5mm	3	Houtvijs	SGK.35156	05064
ALU geanod.	300mm	1.5mm	3	Houtvijs	SGK.35157	06064
ALU geanod.	500mm	1.5mm	3	Houtvijs	SGK.35158	07064
ALU geanod.	1000mm	1.5mm	4	Houtvijs	SGK.35200	35200
ALU geanod.	3000mm	1.5mm	Geen boringen	Houtvijs	SGK.35155.3M	08064
ALU brut	3000mm	1.5mm	Geen boringen	Houtvijs	SGK.35155.3MBR	09064
Messing/gold	3000mm	1.5mm	Geen boringen	Houtvijs	SGK.35155.3MME	09090
Zwart geanod.	3000mm	1.5mm	Geen boringen	Houtvijs	SGK.35155.3MZW	09086

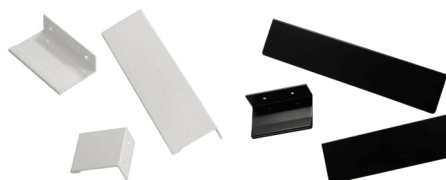

L-GREEP gelakt in wit of zwart

UITVOERING	OVERMETEN	DIKTE	AANTAL BORINGEN	BEVESTIGING	ARTIKEL NR.	SNELCODE
Wit gelakt MAT	40mm	1.5mm	2	Houtvijs	SGK.35159	10064
Wit gelakt MAT	70mm	1.5mm	2	Houtvijs	SGK.35160	11064
Wit gelakt MAT	150mm	1.5mm	3	Houtvijs	SGK.35161	12064
Wit gelakt MAT	300mm	1.5mm	3	Houtvijs	SGK.35162	13064
Wit gelakt MAT	500mm	1.5mm	3	Houtvijs	SGK.35163	14064
Wit gelakt MAT	1000mm	1.5mm	4	Houtvijs	SGK.35201	35201
Zwart gelakt MAT	40mm	1.5mm	2	Houtvijs	SGK.35164	15064
Zwart gelakt MAT	70mm	1.5mm	2	Houtvijs	SGK.35165	16064
Zwart gelakt MAT	150mm	1.5mm	3	Houtvijs	SGK.35166	17064
Zwart gelakt MAT	300mm	1.5mm	3	Houtvijs	SGK.35167	18064
Zwart gelakt MAT	500mm	1.5mm	3	Houtvijs	SGK.35168	19064
Zwart gelakt MAT	1000mm	1.5mm	4	Houtvijs	SGK.35202	35202

Zwarte houtvijzen 3.0x16 - zie pagina N 2



T-greep inox diam.12mm/10mm

BOORAFSTAND	OVERMETEN	HOOGTE	DIAMETER	BEVESTIGING	ARTIKEL NR.	SNELCODE
96mm	146mm	32mm	12mm/10mm	M4 vijs	0706BM2230.096	01001
128mm	178mm	32mm	12mm/10mm	M4 vijs	0706BM2230.128	02001
160mm	210mm	32mm	12mm/10mm	M4 vijs	0706BM2230.160	03001
192mm	242mm	32mm	12mm/10mm	M4 vijs	0706BM2230.192	04001
224mm	274mm	32mm	12mm/10mm	M4 vijs	0706BM2230.224	05001
288mm	338mm	32mm	12mm/10mm	M4 vijs	0706BM2230.288	07001
352mm	402mm	32mm	12mm/10mm	M4 vijs	0706BM2230.352	09001
384mm	434mm	32mm	12mm/10mm	M4 vijs	0706BM2230.384	10001
448mm	498mm	32mm	12mm/10mm	M4 vijs	0706BM2230.448	12001
544mm	594mm	32mm	12mm/10mm	M4 vijs	0706BM2230.544	15001



T-greep inox look diam.12mm/10mm

BOORAFSTAND	OVERMETEN	HOOGTE	DIAMETER	BEVESTIGING	ARTIKEL NR.	SNELCODE
96mm	156mm	32mm	12mm/10mm	M4 vijs	0706GR852521096	01004
128mm	188mm	32mm	12mm/10mm	M4 vijs	0706GR852521128	02004
160mm	220mm	32mm	12mm/10mm	M4 vijs	0706GR852521160	03004
192mm	252mm	32mm	12mm/10mm	M4 vijs	0706GR852521192	04004
224mm	284mm	32mm	12mm/10mm	M4 vijs	0706GR852521224	05004
256mm	316mm	32mm	12mm/10mm	M4 vijs	0706GR852521256	06004
288mm	348mm	32mm	12mm/10mm	M4 vijs	0706GR852521288	07004
320mm	380mm	32mm	12mm/10mm	M4 vijs	0706GR852521320	08004
352mm	412mm	32mm	12mm/10mm	M4 vijs	0706GR852521352	09004
384mm	444mm	32mm	12mm/10mm	M4 vijs	0706GR852521384	10004
448mm	508mm	32mm	12mm/10mm	M4 vijs	0706GR852521448	11004
480mm	540mm	32mm	12mm/10mm	M4 vijs	0706GR852521480	12004
511mm	571mm	32mm	12mm/10mm	M4 vijs	0706GR852521511	13004
576mm	636mm	32mm	12mm/10mm	M4 vijs	0706GR852521576	14004
640mm	690mm	32mm	12mm/10mm	M4 vijs	0706GR852521640	15004
736mm	796mm	32mm	12mm/10mm	M4 vijs	0706GR852521736	16004
884mm	944mm*	32mm	12mm/10mm	M4 vijs	0706GR852531108	17004
1136mm	1196mm*	32mm	12mm/10mm	M4 vijs	0706GR852531136	19004

* = 3 steunen in plaats van 2

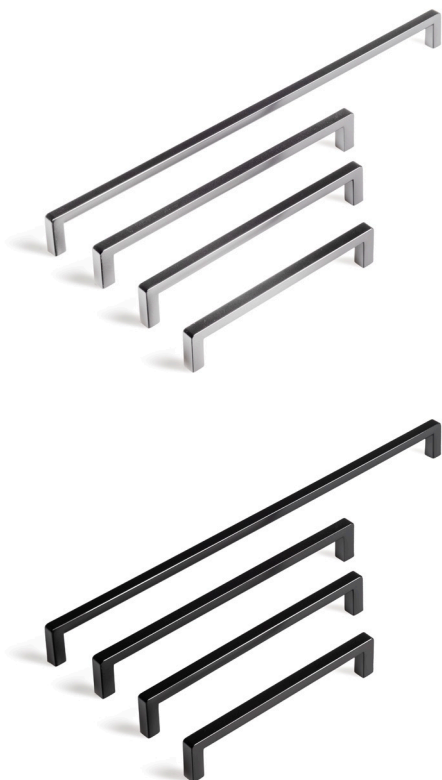

THIN greep inox look

BOORAFSTAND	OVERMETEN	HOOGTE	DIAMETER	BEVESTIGING	ARTIKEL NR.	SNELCODE
96mm	104mm	28mm	9mm	M4 vijs	0706GR08941319	02031
128mm	136mm	28mm	9mm	M4 vijs	0706GR08941419	03031
160mm	168mm	28mm	9mm	M4 vijs	0706GR08941519	04031
192mm	200mm	28mm	9mm	M4 vijs	0706GR08941619	05031
320mm	328mm	28mm	9mm	M4 vijs	0706GR08942019	06031
448mm	456mm	28mm	9mm	M4 vijs	0706GR08942319	07031

THIN greep mat zwart gelakt

BOORAFSTAND	OVERMETEN	HOOGTE	DIAMETER	BEVESTIGING	ARTIKEL NR.	SNELCODE
96mm	104mm	28mm	9mm	M4 vijs	0706GR089413ZW	08031
128mm	136mm	28mm	9mm	M4 vijs	0706GR089414ZW	09031
160mm	168mm	28mm	9mm	M4 vijs	0706GR089415ZW	10031
192mm	200mm	28mm	9mm	M4 vijs	0706GR089416ZW	11031
320mm	328mm	28mm	9mm	M4 vijs	0706GR089420ZW	12031

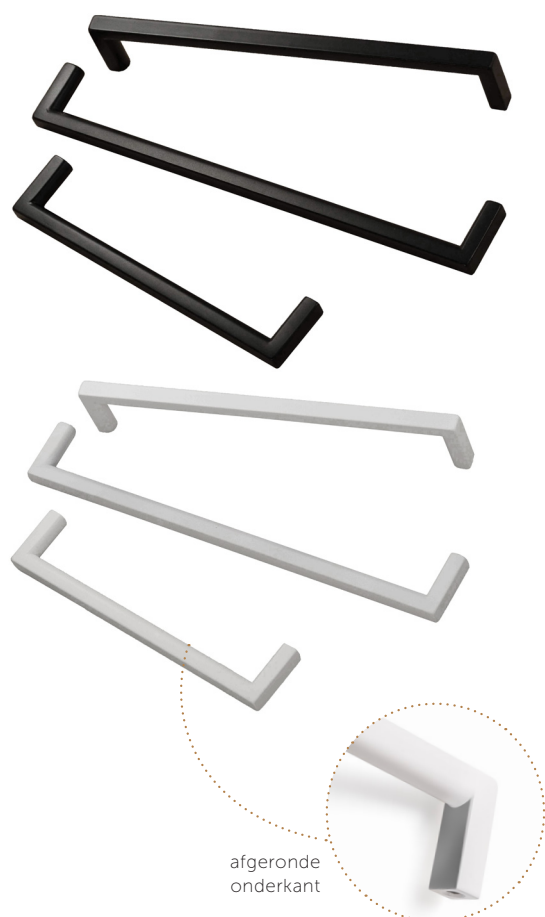

PROJECT GREEP wit & zwart

UITVOERING	BOORAFSTAND	OVERMETEN	HOOGTE	DIAMETER	BEVESTIGING	ARTIKEL NR.	SNELCODE
Zwart	128mm	136mm	28mm	8mm	M4 vijs	0706GR8583260128	85832
Zwart	160mm	168mm	28mm	8mm	M4 vijs	0706GR8583260160	85834
Zwart	192mm	200mm	28mm	8mm	M4 vijs	0706GR8583260192	85836
Zwart	320mm	328mm	28mm	8mm	M4 vijs	0706GR8583260320	85838
Wit	128mm	136mm	28mm	8mm	M4 vijs	0706GR8583200128	85831
Wit	160mm	168mm	28mm	8mm	M4 vijs	0706GR8583200160	85833
Wit	192mm	200mm	28mm	8mm	M4 vijs	0706GR8583200192	85835
Wit	320mm	328mm	28mm	8mm	M4 vijs	0706GR8583200320	85837



SANTA CRUZ greep mat vernikkeld

BOORAFSTAND	OVERMETEN	BREEDTE	BEVESTIGING	ARTIKEL NR.	SNELCODE
128mm	186mm	23mm	M4 vijs	0706GR8562427	01046



SENEGAL greep inox look

BOORAFSTAND	OVERMETEN	BREEDTE	BEVESTIGING	ARTIKEL NR.	SNELCODE
128mm	152mm	20mm	M4 vijs	0706GR8744419	02046



SOFIA greep inox look

BOORAFSTAND	OVERMETEN	DIAMETER	BEVESTIGING	ARTIKEL NR.	SNELCODE
128mm	144mm	16mm	M4 vijs	0706GR08594419	03046



BOW greep

UITVOERING	BOORAFSTAND	DIAMETER	BEVESTIGING	ARTIKEL NR.	SNELCODE
Inox	96mm	10mm	M4 vijs	0706BM2270.096	01007
Inox	128mm	10mm	M4 vijs	0706BM2270.128	02007
Inox	160mm	10mm	M4 vijs	0706BM2270.160	03007
Inox	192mm	10mm	M4 vijs	0706BM2270.192	04007
Zwart	96mm	10mm	M4 vijs	0706ZW7214-096	73096
Zwart	128mm	10mm	M4 vijs	0706ZW7214-128	73128
Zwart	160mm	10mm	M4 vijs	0706ZW7214-160	73160
Zwart	192mm	10mm	M4 vijs	0706ZW7214-192	73192
Zwart	320mm	10mm	M4 vijs	0706ZW7214-320	73320



BEUGEL greep inox

BOORAFSTAND	OVERMETEN	HOOGTE	DIAMETER	BEVESTIGING	ARTIKEL NR.	SNELCODE
96mm	106mm	35mm	10mm	M4 vijs	0706GR72214317	07006
128mm	138mm	35mm	10mm	M4 vijs	0706GR72214417	08006
160mm	170mm	35mm	10mm	M4 vijs	0706GR72214517	09006
192mm	202mm	35mm	10mm	M4 vijs	0706GR72214617	10006
224mm	234mm	35mm	10mm	M4 vijs	0706GR72214717	11006
288mm	298mm	35mm	10mm	M4 vijs	0706GR72214917	12006
320mm	330mm	35mm	10mm	M4 vijs	0706GR72215017	13006
448mm	458mm	35mm	10mm	M4 vijs	0706GR72215217	14006
512mm	522mm	35mm	10mm	M4 vijs	0706GR72126117	15006

BEUGEL greep zwart

BOORAFSTAND	OVERMETEN	HOOGTE	DIAMETER	BEVESTIGING	ARTIKEL NR.	SNELCODE
96mm	106mm	32mm	10mm	M4 vijs	0706ZW7213-096	72096
128mm	138mm	32mm	10mm	M4 vijs	0706ZW7213-128	72128
160mm	170mm	32mm	10mm	M4 vijs	0706ZW7213-160	72160
192mm	202mm	32mm	10mm	M4 vijs	0706ZW7213-192	72192

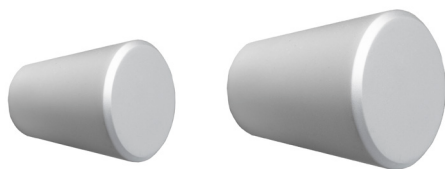

PYRA knop

UITVOERING	DIAMETER	HOOGTE	BEVESTIGING	ARTIKEL NR.	SNELCODE
Aluminium	20mm	25mm	M4 vijs	0706GR72157547	01069
Aluminium	24mm	29mm	M4 vijs	0706GR72157647	02069
Inox	20mm	25mm	M4 vijs	0706GR72157517	05069
Inox	24mm	30mm	M4 vijs	0706GR72157617	06069
Inox	29mm	35mm	M4 vijs	0706GR72157817	07069

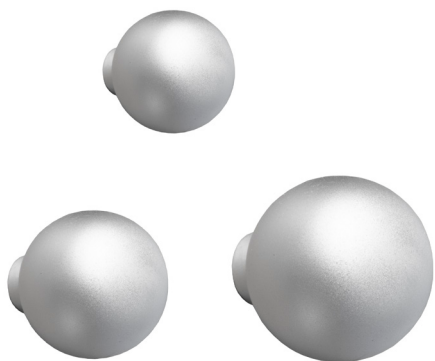

BOL knop

UITVOERING	DIAMETER	HOOGTE	BEVESTIGING	ARTIKEL NR.	SNELCODE
Aluminium	20mm	22mm	M4 vijs	0706GR72211047	01070
Aluminium	25mm	27mm	M4 vijs	0706GR72211147	02070
Aluminium	30mm	32mm	M4 vijs	0706GR72211247	03070
Inox	20mm	22mm	M4 vijs	0706GR72211017	04070
Inox	25mm	27mm	M4 vijs	0706GR72211117	05070
Inox	30mm	32mm	M4 vijs	0706GR72211217	06070



KRAAN knop

UITVOERING	OVERMETEN	HOOGTE	BEVESTIGING	ARTIKEL NR.	SNELCODE
Inox look	50mm	40mm	M4 vijs	0706GR72395019	01076



KRAAN knop met pin

UITVOERING	OVERMETEN	HOOGTE	BEVESTIGING	ARTIKEL NR.	SNELCODE
Inox look	45mm	35mm	M4 vijs	FW36849-001+PIN	36849



RONDO knop

UITVOERING	DIAMETER	HOOGTE	BEVESTIGING	ARTIKEL NR.	SNELCODE
Aluminium	12mm	20mm	M4 vijs	0706GR72052347	01067
Aluminium	15mm	22mm	M4 vijs	0706GR72052247	02067
Aluminium	18mm	25mm	M4 vijs	0706GR72052147	03067
Aluminium	21mm	27mm	M4 vijs	0706GR72052047	04067
Inox	12mm	20mm	M4 vijs	0706GR72052317	05067
Inox	15mm	22mm	M4 vijs	0706GR72052217	06067
Inox	18mm	25mm	M4 vijs	0706GR72052117	07067
Inox	21mm	27mm	M4 vijs	0706GR72052017	08067
Mat zwart	15mm	26mm	M4 vijs	0706 FH302-15Z	21918
Mat zwart	20mm	28mm	M4 vijs	0706 FH302-20Z	21921
Mat zwart	25mm	30mm	M4 vijs	0706 FH302-25Z	21923

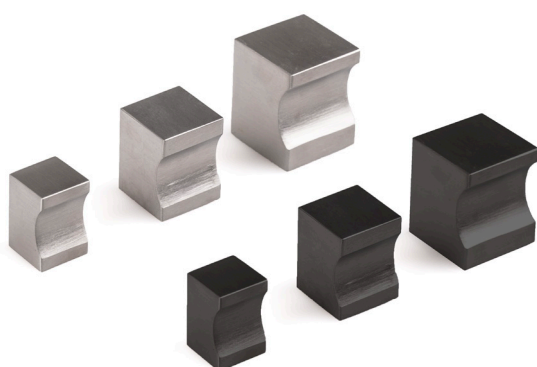

QUADRO knop

UITVOERING	AFMETINGEN	HOOGTE	BEVESTIGING	ARTIKEL NR.	SNELCODE
Inox	15x15mm	20mm	M4 vijs	0706 FH319.15	01068
Inox	20x20mm	25mm	M4 vijs	0706 FH319.20	02068
Inox	25x25mm	30mm	M4 vijs	0706 FH319.25	03068
Mat zwart	15x15mm	20mm	M4 vijs	0706 FH319.15ZW	04068
Mat zwart	20x20mm	25mm	M4 vijs	0706 FH319.20ZW	05068
Mat zwart	25x25mm	30mm	M4 vijs	0706 FH319.25ZW	06068

Meubelpoten

Decoratieve meubelpoten zijn een essentieel onderdeel om het uiterlijk en de uitstraling van een meubelstuk te verbeteren. Of het nu gaat om een bank, een salontafel of een kast, meubelpoten voegen een vleugje elegantie en stijl toe aan de algehele esthetiek van het meubel.

Naast hun esthetische waarde hebben decoratieve meubelpoten ook functionele voordelen. Ze zorgen voor stabiliteit en ondersteuning van het meubelstuk, waardoor het duurzamer wordt. Bovendien kunnen meubelpoten worden aangepast aan de gewenste hoogte, waardoor het meubelstuk beter aangepast kan worden aan de persoonlijke behoeften en voorkeuren van de gebruiker.



FONDA meubelpoot

UITVOERING	HOOGTE	HOOGTEREGELING	ARTIKEL NR.	SNELCODE
Chromé glans	100mm	4mm	VIE6005-100-CH	60051
Chromé glans	150mm	4mm	VIE6005-150-CH	60055
Chromé glans	200mm	4mm	VIE6005-200-CH	60059
Goud	100mm	4mm	VIE6005-100-GO	60053
Goud	150mm	4mm	VIE6005-150-GO	60056
Goud	200mm	4mm	VIE6005-200-GO	60060
Inox look	100mm	4mm	VIE6005-100-IL	60052
Inox look	150mm	4mm	VIE6005-150-IL	60057
Inox look	200mm	4mm	VIE6005-200-IL	60061
Zwart	100mm	4mm	VIE6005-100-ZW	60054
Zwart	150mm	4mm	VIE6005-150-ZW	60058
Zwart	200mm	4mm	VIE6005-200-ZW	60062



STRONG meubelpoot aluminium en zwart

UITVOERING	HOOGTE	VIERKANT	BOVENPLAAT	ARTIKEL NR.	SNELCODE
Alu meubelpoot	80mm	38x38mm	80x80mm	POOT.ALU.080	97201
Alu meubelpoot	100mm	38x38mm	80x80mm	POOT.ALU.100	97203
Alu meubelpoot	120mm	38x38mm	80x80mm	POOT.ALU.120	97205
Zwarte meubelpoot	80mm	38x38mm	80x80mm	POOT.ZWA.080	97202
Zwarte meubelpoot	100mm	38x38mm	80x80mm	POOT.ZWA.100	97204
Zwarte meubelpoot	120mm	38x38mm	80x80mm	POOT.ZWA.120	97206

Verwerking

metaalvijzen & sjablonen

Wij leveren steeds de gepaste vijzen gratis mee voor de montage van je knoppen en grepen, maar soms heb je al eens een afwijkende lengte, uitvoering of dikte nodig voor een specifieke toepassing. Je kan die los bijbestellen alsook een afteken-sjabloon voor je grepen dat je handig op de juiste boormaat kunt instellen zodat je niet steeds opnieuw moet opmeten en aftekenen.

Metaalvijs op verschillende lengtes. Uitermate geschikt voor bevestiging van knoppen en grepen aan fronten en deuren door platte onderzijde van de kop.



Metaalvijs M4 verzinkt

DOOS	ARTIKEL NR.	DOOS	ARTIKEL NR.
1000	0511 M4x10 KZ	1000	0511 M4x28 KZ
1000	0511 M4x12 KZ	1000	0511 M4x29 KZ
1000	0511 M4x15 KZ	1000	0511 M4x30 KZ
1000	0511 M4x19 KZ	1000	0511 M4x35 KZ
1000	0511 M4x21 KZ	1000	0511 M4x40 KZ
1000	0511 M4x22 KZ	1000	0511 M4x45 KZ
1000	0511 M4x23 KZ	1000	0511 M4x50 KZ
1000	0511 M4x25 KZ	1000	0511 M4x55 KZ
1000	0511 M4x26 KZ	1000	0511 M4x60 KZ
1000	0511 M4x27 KZ		



Metaalvijs M6

UITVOERING	OMSCHRIJVING	ARTIKEL NR.
Vernikkeld	M6 metaalvijs M6x25	0511 M6PLK6x25N
Vernikkeld	M6 metaalvijs M6x30	0511 M6PLK6x30N
Vernikkeld	M6 metaalvijs M6x35	0511 M6PLK6x35N
Vernikkeld	M6 metaalvijs M6x40	0511 M6PLK6x40N
Zwart	M6 metaalvijs M6x25	0511 M6PLK6x25Z
Zwart	M6 metaalvijs M6x30	0511 M6PLK6x30Z
Zwart	M6 metaalvijs M6x35	0511 M6PLK6x35Z
Zwart	M6 metaalvijs M6x40	0511 M6PLK6x40Z

Houtvijs SPAX zwart



OMSCHRIJVING	ARTIKEL NR.
SPAX-S schroef TORX 3,0x16 zwart VE200 T10	0558 3.0x16ZW

Sjabloon boorgaten voor grepen



OMSCHRIJVING	ARTIKEL NR.	SNELCODE
Matrijs voorboren boorgaten	0706 317802	01147

Bezoek onze showroom
BOUWELVEN 16
2280 GROBBENDONK

Bestel via onze webshop
WWW.DU-PONT.BE

